

Building Vocabulary



Nehiyawewin Terms

100 words using flashcards

25 Household Terms with pictures & plural terms (p1)



yōski-tēhtapiwin
yōski-tēhtapiwina



maskimot
maskimota

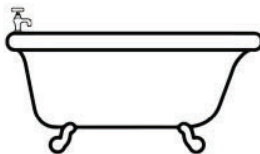

kisīhpēkastākan
kisīhpēkastākana

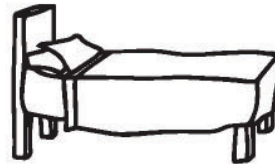

nipēwin
nipēwina

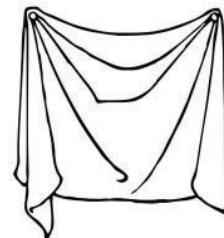

anāskān
anāskāna



akōhp
akōhpa



oyākanis
oyākanisa

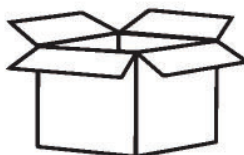

mistikōwat
mistikōwata



wēpahikan
wēpahikana



sēkēpayīs
sēkēpayīsak



tēhtapiwin
tēhtapiwina

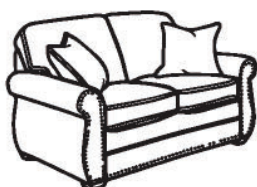

kinoyōski-tēhtapiwin
kinoyōski-tēhtapiwina

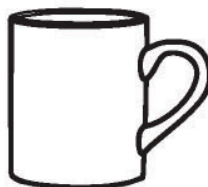

minīhwākanis
minīhwākanisa

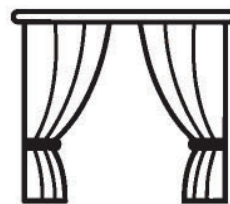

ākohpicikan
ākohpicikana



wāsēnamāwin
wāsēnamāwina

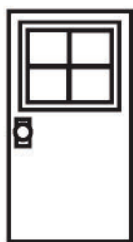

iskwāhtēm
iskwāhtēma

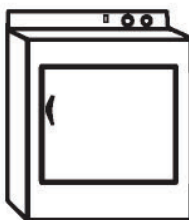

pāsikākan
pāsikākana



cīstēpōhwinis
cīstēpōhwinisa



tākascikan
tākascikana



napwēn
napwēnak



pakamākanis
pakamākanisa



astotin
astotina



wāskahikan
wāskahikana



miskotākay
miskotākaya

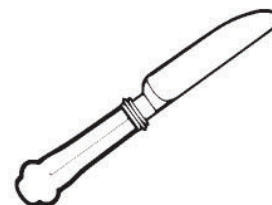

mōhkomānis
mōhkomānisa

25 Household Terms with pictures & plural terms (p2)

				
kwāpahikan kwāpahikana	wāpamon wāpamona	kāsītakahikan kāsītakahikana	askihk askihkwak	mitās mitāsak
				
papēskomina papēskomina	aspiskwēsimon aspiskwēsimona	napakīyākan napakīyākana	pakācikan pakācikanak	pākopēwaskisin pākopēwaskisina
				
siwīhtākan siwīhtākan	kīskipohcikan kīskipohcikana	paskwāhamātowin paskwāhamātowina	pīmahikan pīmahikana	pakowayān pakowayāna
				
maskisin maskisina	asikan asikanak	ēmīhwānis ēmīhwānisak	kohtawānāpisk kohtawānāpiskwak	mīcisōwināhtik mīcisōwināhtikwa
				
pākōkwēhon pākōkwēhona	macikwanās-asōwacikan macikwanās-asōwacikana	cakāstēpayicikan cakāstēpayicikana	kisīhpēkinikēpayīs kisīhpēkinikēpayīsa	masinapahīcikan masinapahīcikana

25 Household Terms with pictures & plural terms (p3)

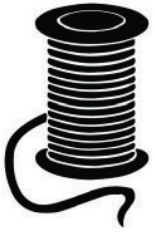

asapāp
asapāpak



miskīsikōkāna
miskīsikōkāna



sīsīpiwaskihk
sīsīpiwaskihkwak



saskahikan
saskahikana



sōniskwātahan
sōniskwātahanak

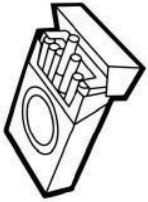

pīhcwākanis
pīhcwākanisak



sāponikan
sāponikana



misawēpayicikan
misawēpayicikana

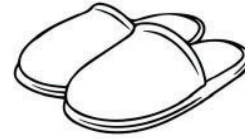

pīhcāyi-askisin
pīhcāyi-askisina



mōtēyāpisk
mōtēyāpiskwa



āwātāwāswākan
āwātāwāswākanak

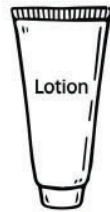

tōminikan
tōminikana



sīwinikan
sīwinikan



pakān-pimīy
pakān-pimīy



wīkicēskōwakās
wīkicēskōwakās



tōhtōhsāpōpimīy
tōhtōhsāpōpimīy



wīsakimanahikan
wīsakimanahikan



napatāk
napatākwa



sikipohcikan
sikipohcikana



awāsīkān
awāsīkānak

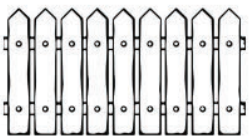

mēnikan
mēnikana



sipayikahikākan
sipayikahikākana

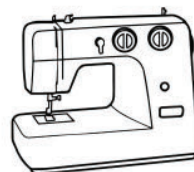

kaskwāsowipayīs
kaskwāsowipayīsa

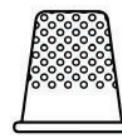

kaskwāsōnāpiskos
kaskwāsōnāpiskwak



ākwanān
ākwanānak

25 Household Terms with pictures & plural terms (p4)

 <p>pīkiskwēmōhcikan pīkiskwēmōhcikana</p>	 <p>pākēkinwēskisin pākēkinwēskisina</p>	 <p>pīsimōhkān pīsimōhkānak</p>	 <p>mētawākan mētawākana</p>	 <p>pakwāhtēhon pakwāhtēhona</p>
 <p>wāsaskotēnikan wāsaskotēnikana</p>	 <p>wāskotēpicikan wāskotēpicikana</p>	 <p>mīcisōwināhcikos mīcisōwināhcikosa</p>	 <p>masinahikan masinahikana</p>	 <p>tākopicikākan tākopicikākana</p>
 <p>sīkahon sīkahona</p>	 <p>kisīhpēkinikan kisīhpēkinikana</p>	 <p>pīhkātēwāpoy pīhkātēwāpoy</p>	 <p>sōniyāw sōniyāw</p>	 <p>āmōwomēy āmōwomēy</p>
 <p>naminās naminās</p>	 <p>sōniyāwasinahikan sōniyāwasinahikana</p>	 <p>wāskotēpicikan wāskotēpicikana</p>	 <p>kimisāwākan kimisāwākana</p>	 <p>mīcimāpoy mīcimāpoya</p>
 <p>sōniyāwacis sōniyāwacis</p>	 <p>sōniyāwacis sōniyāwacis</p>	 <p>kwāskēpicikan kwāskēpicikana</p>	 <p>kihtohwēpicikan kihtohwēpicikana</p>	 <p>pāskisikan pāskisikana</p>

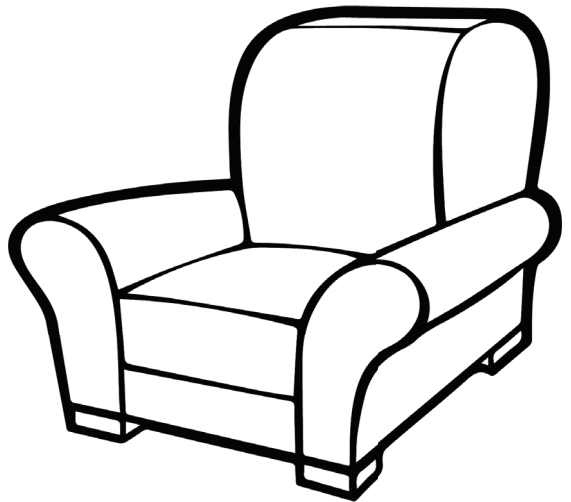
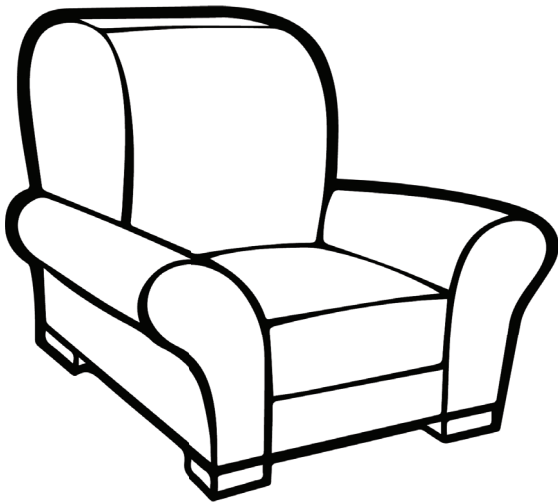
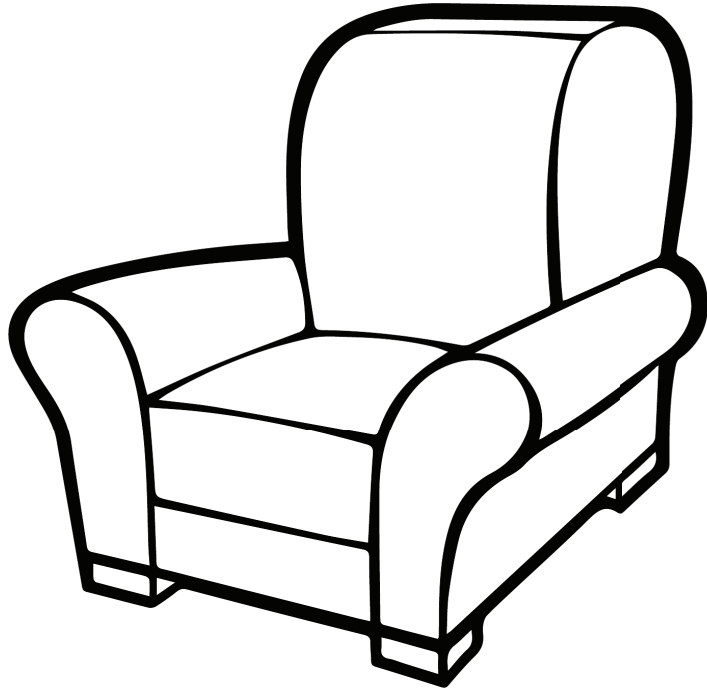

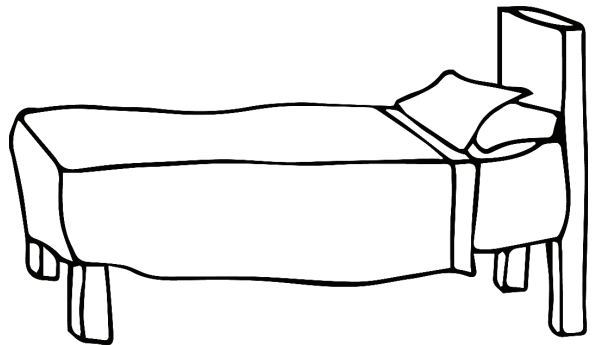
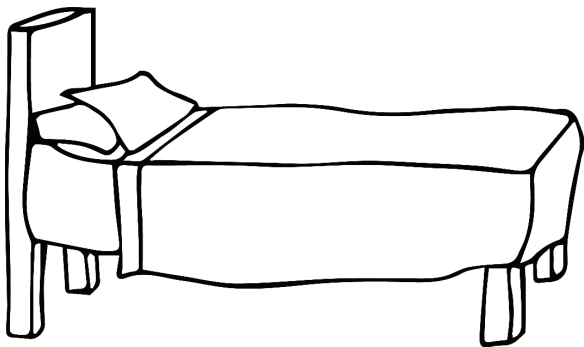
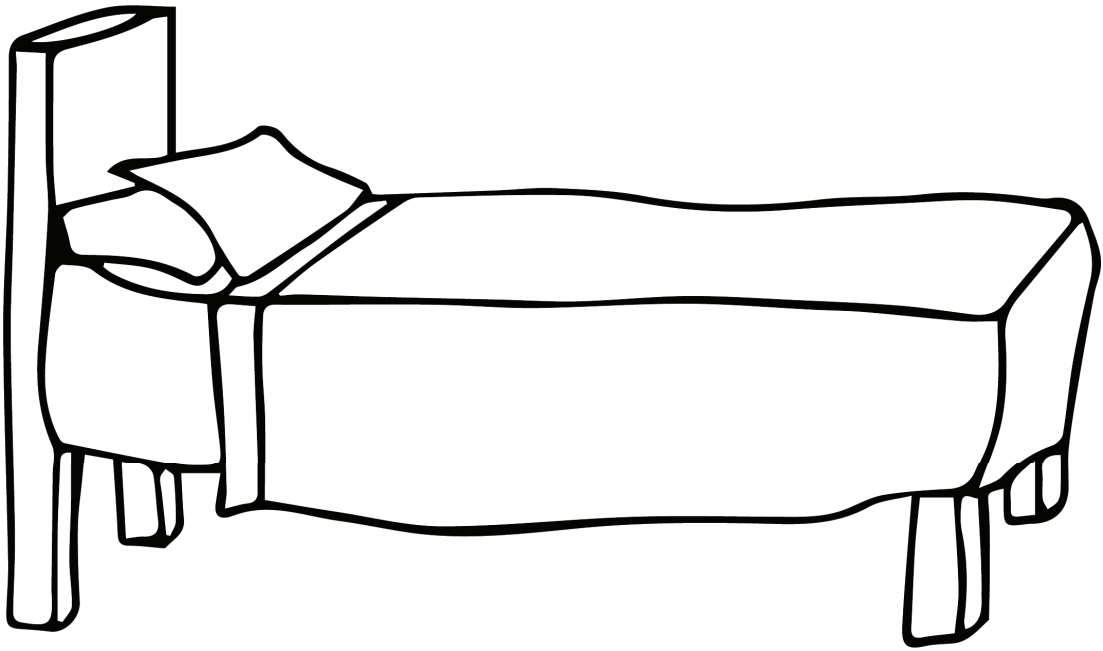

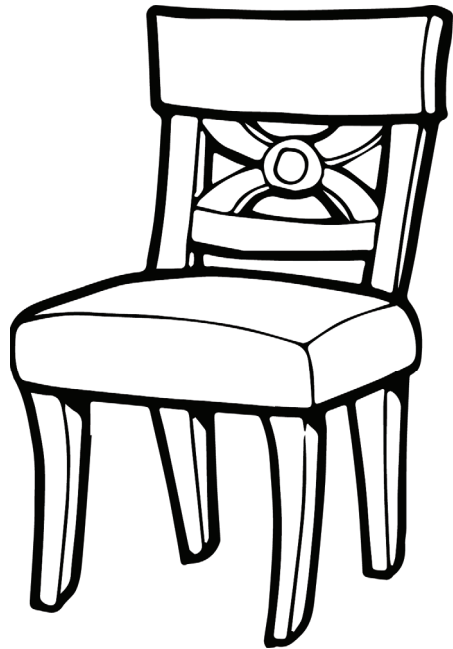
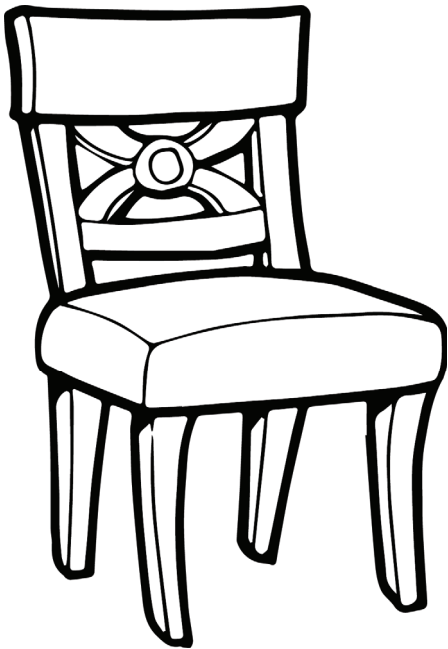
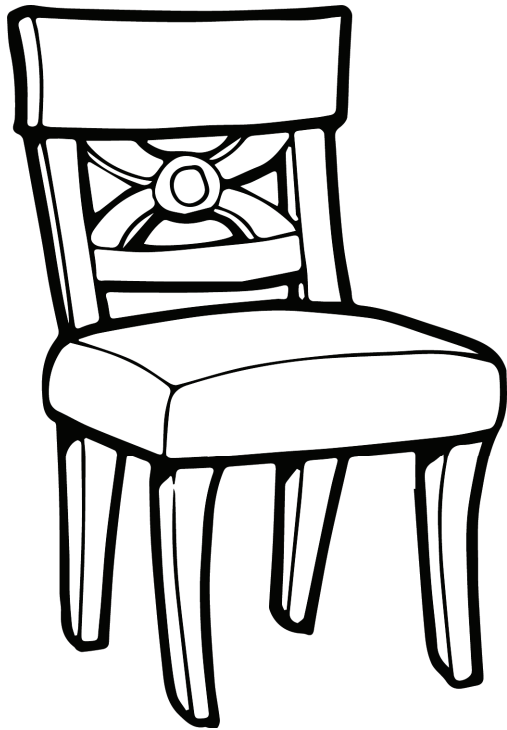

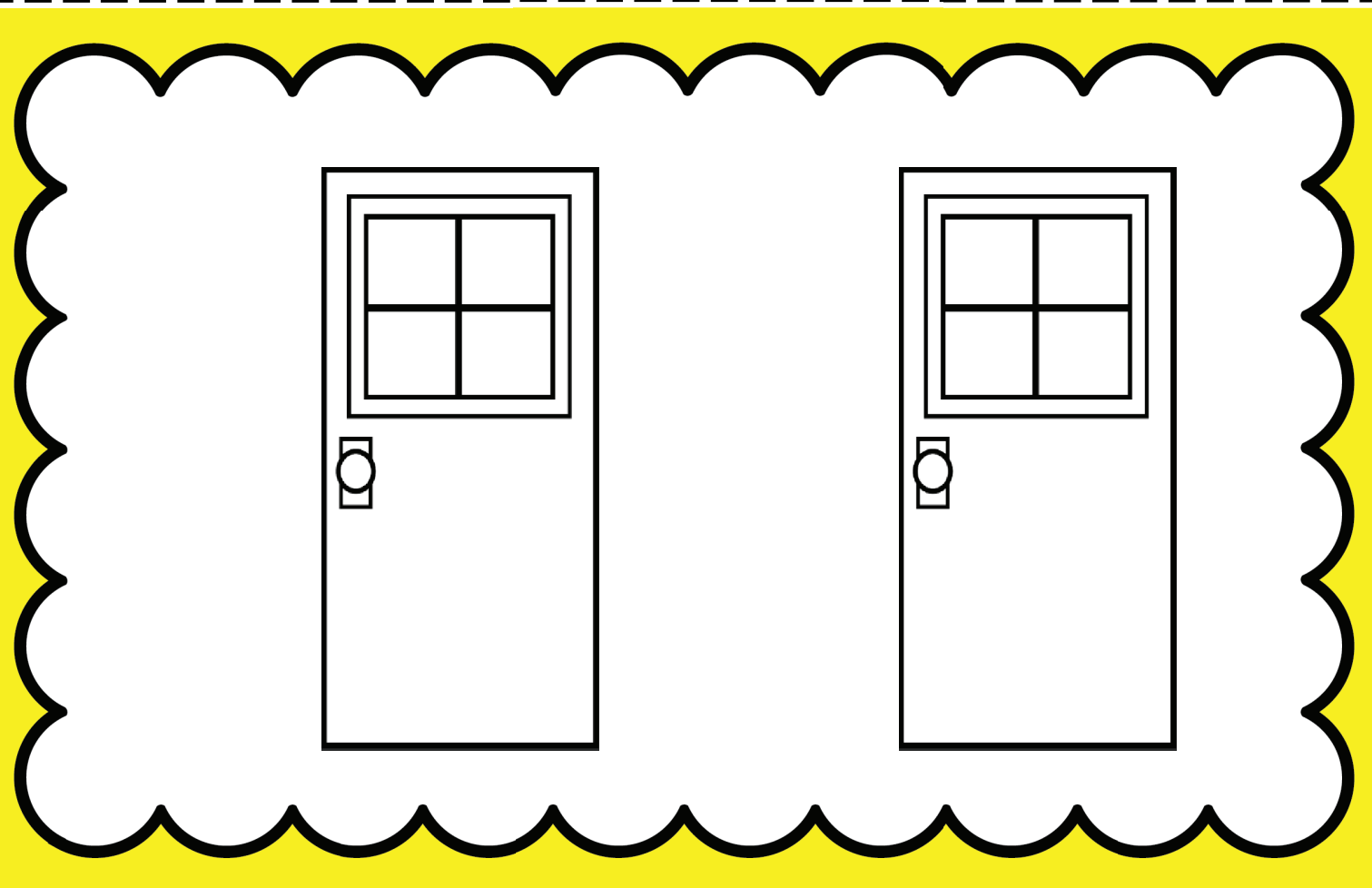
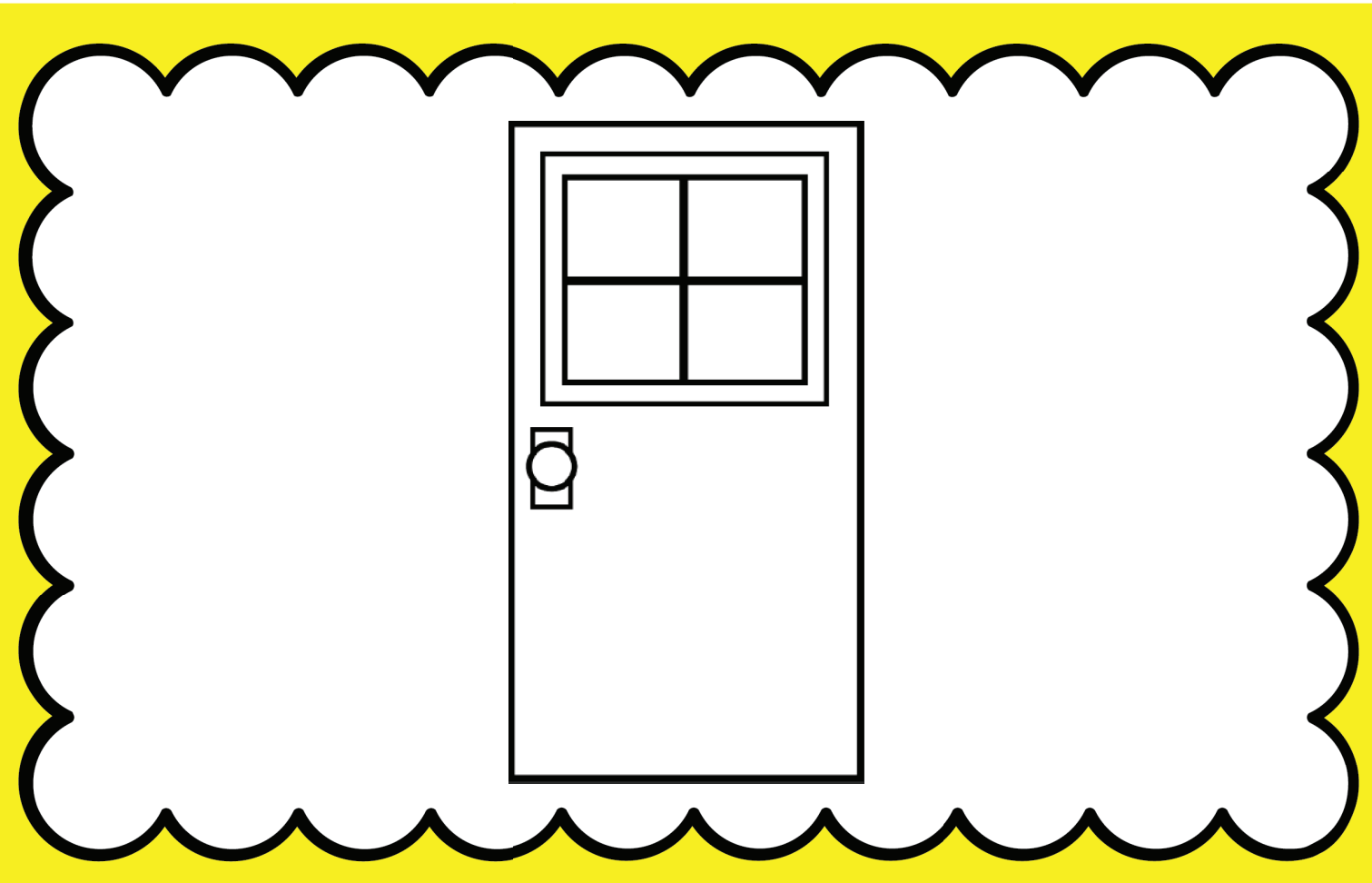

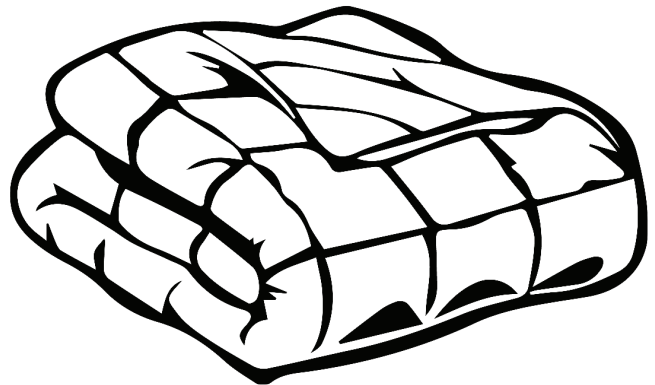
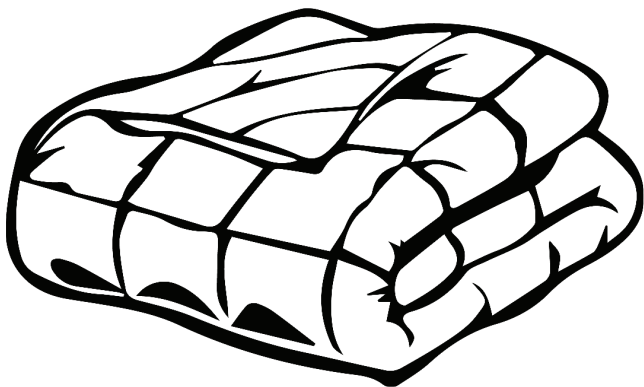
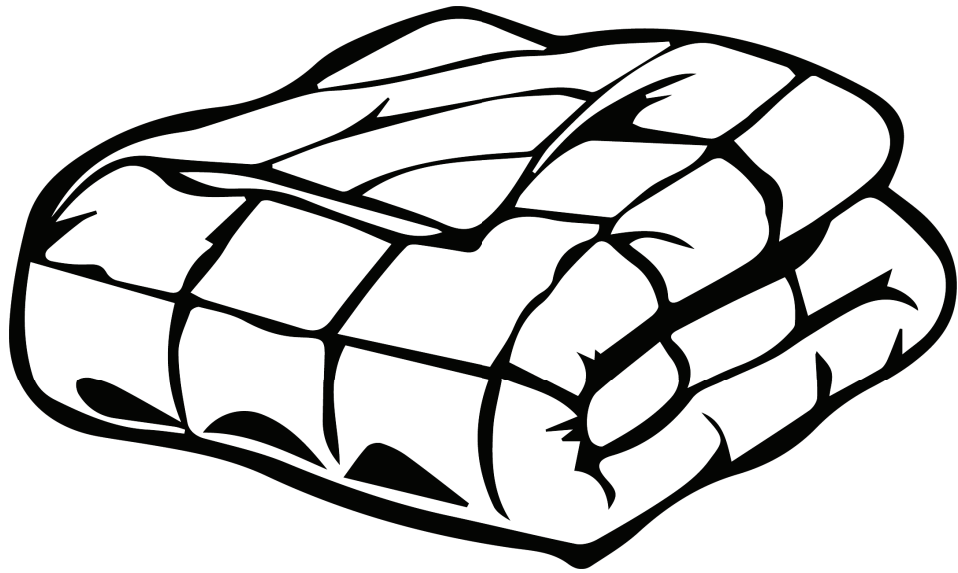

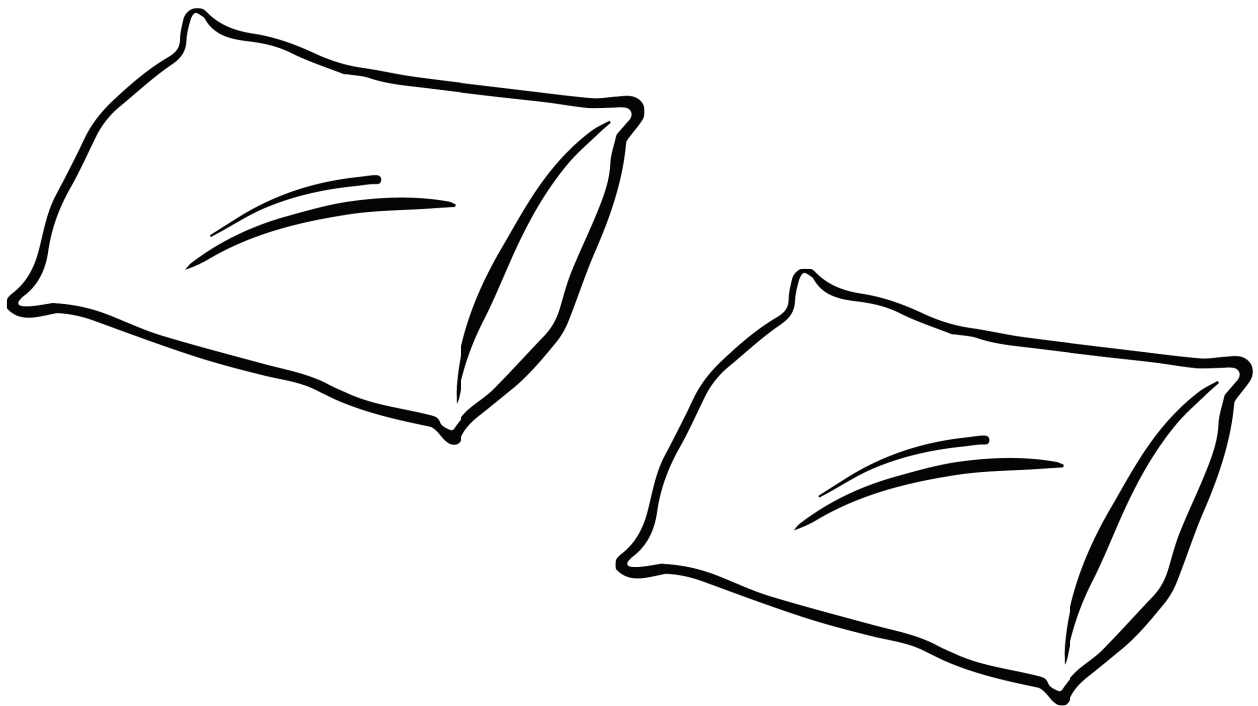
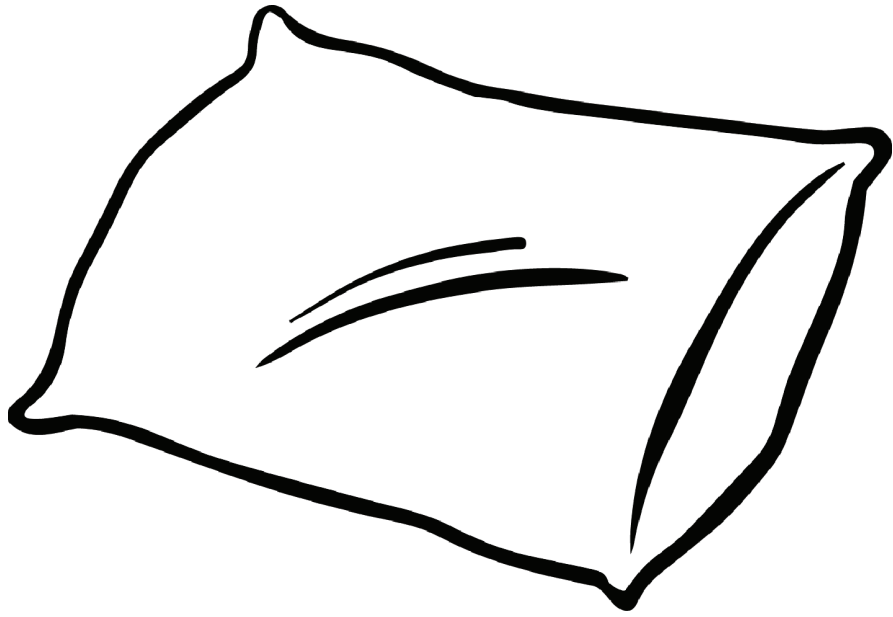

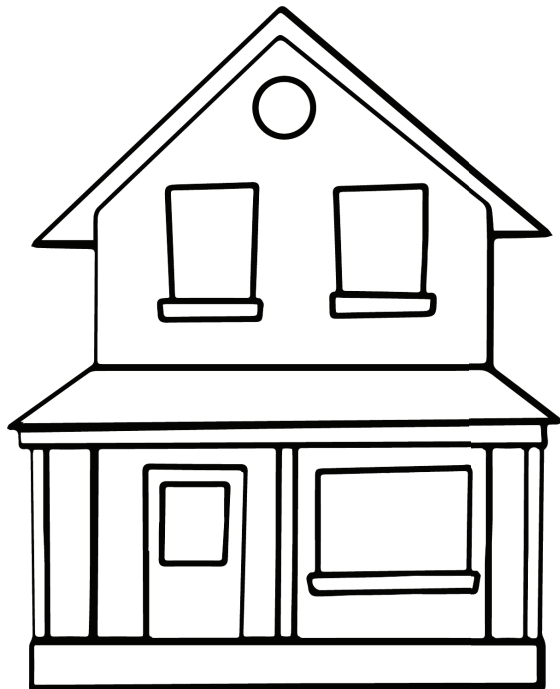
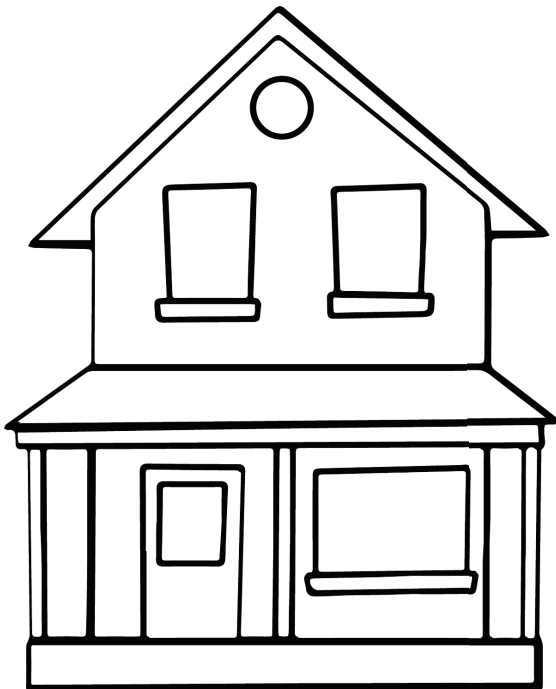
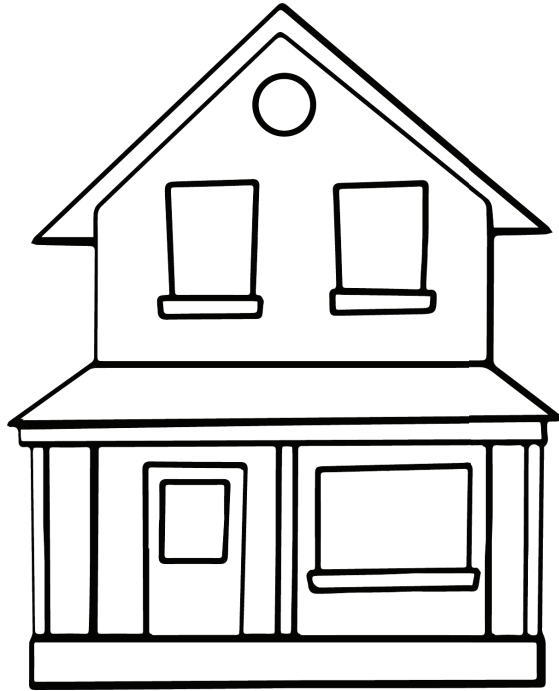

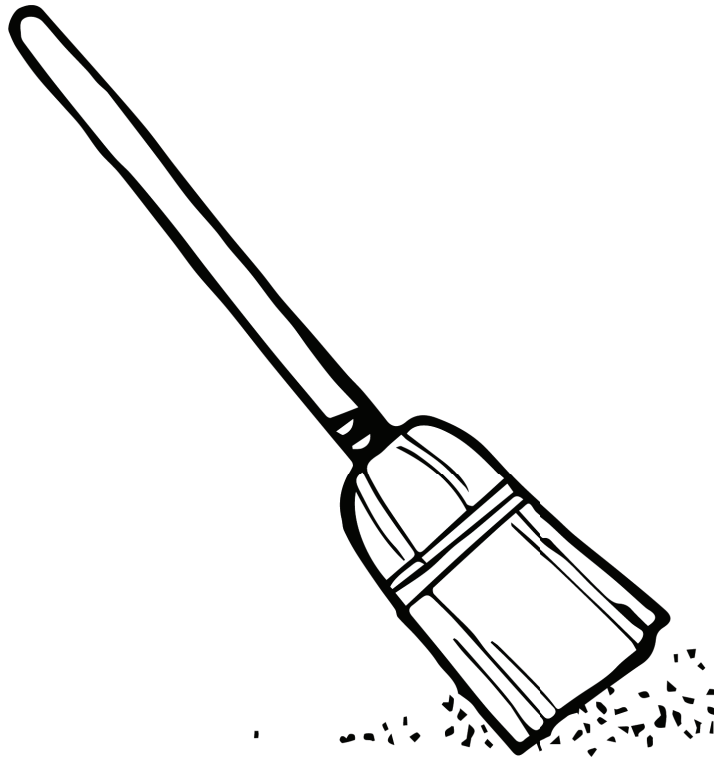

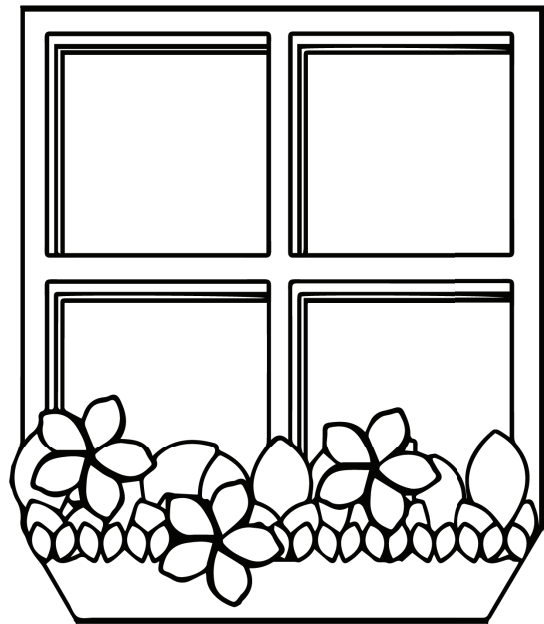
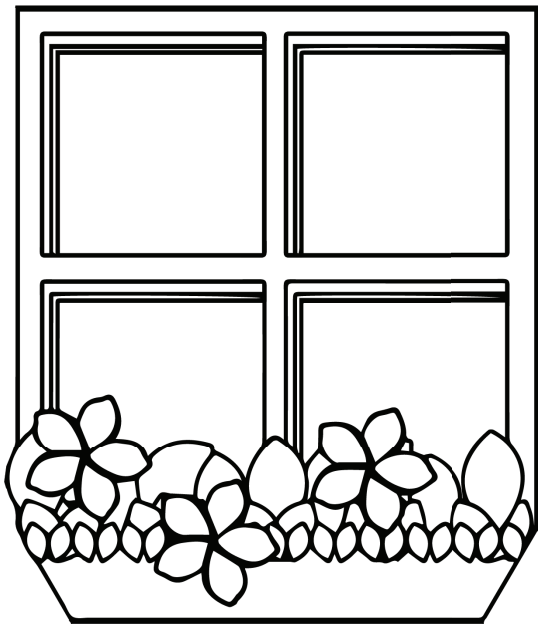
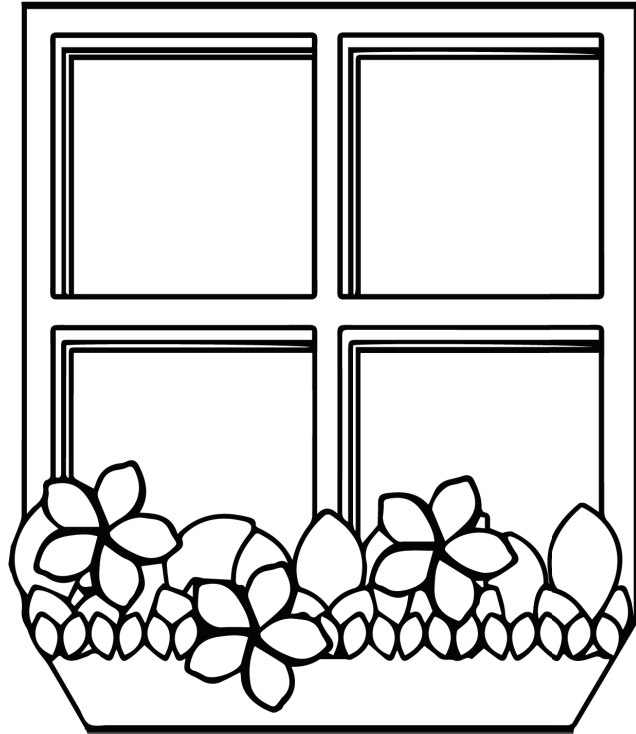



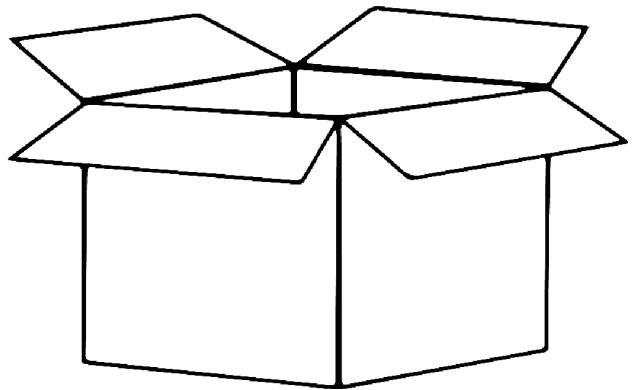
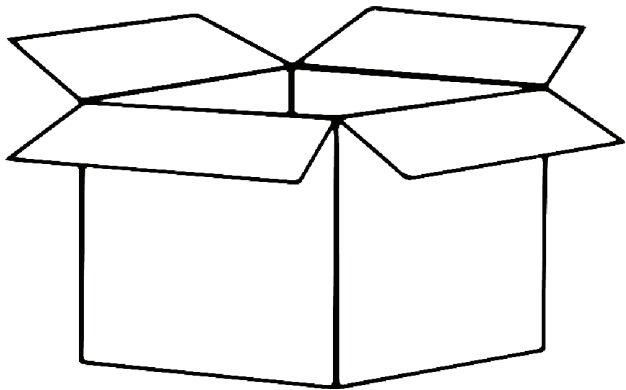
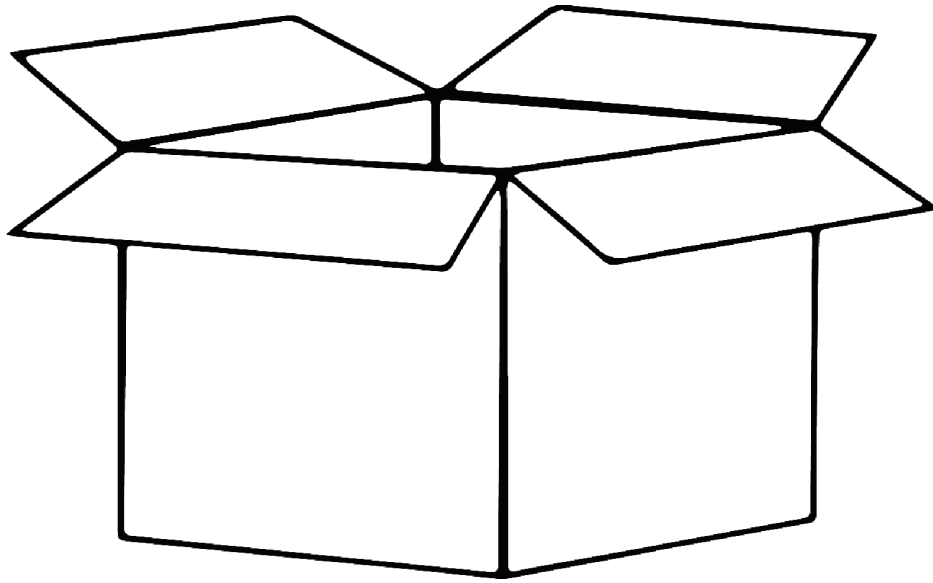

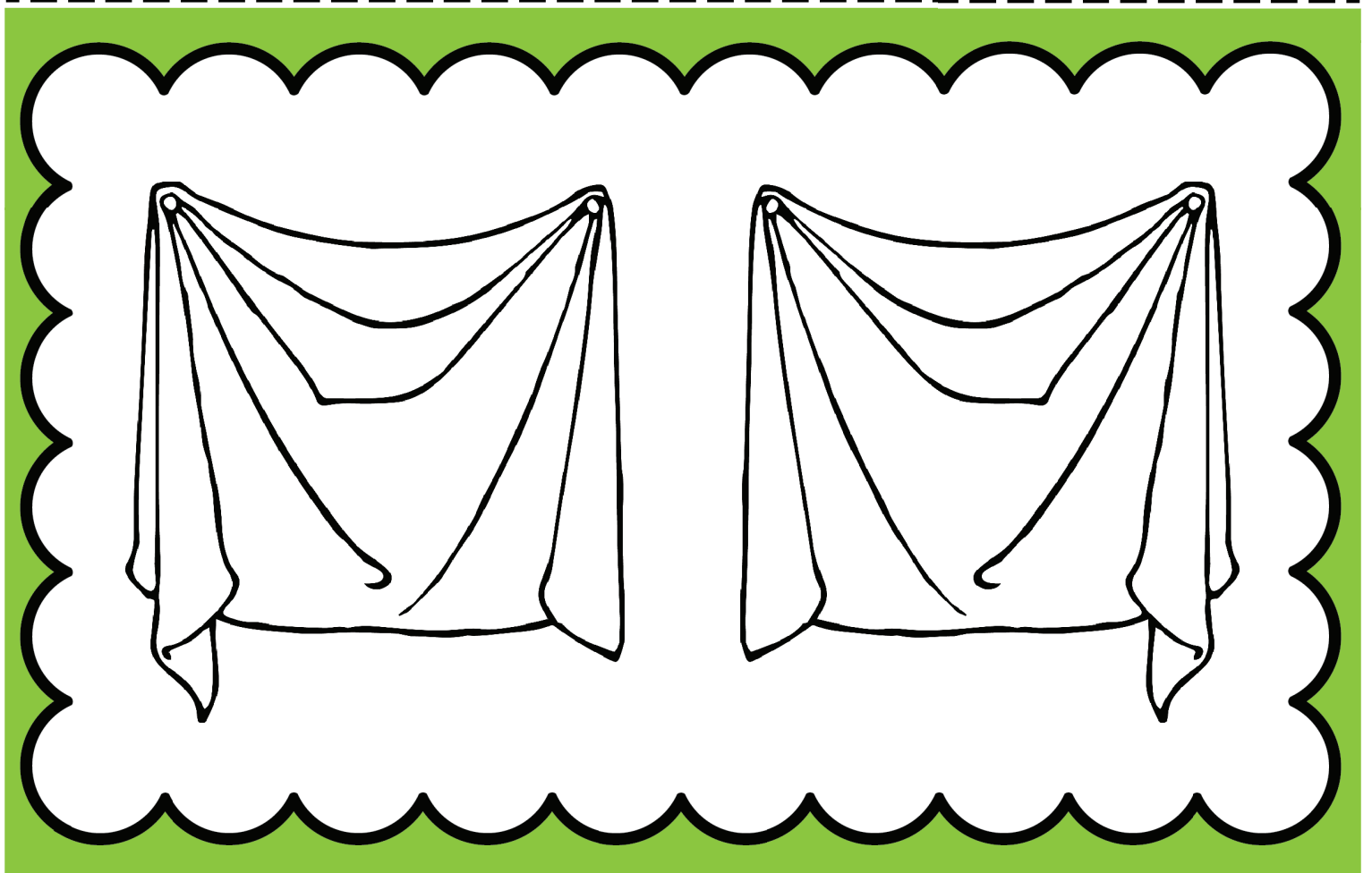
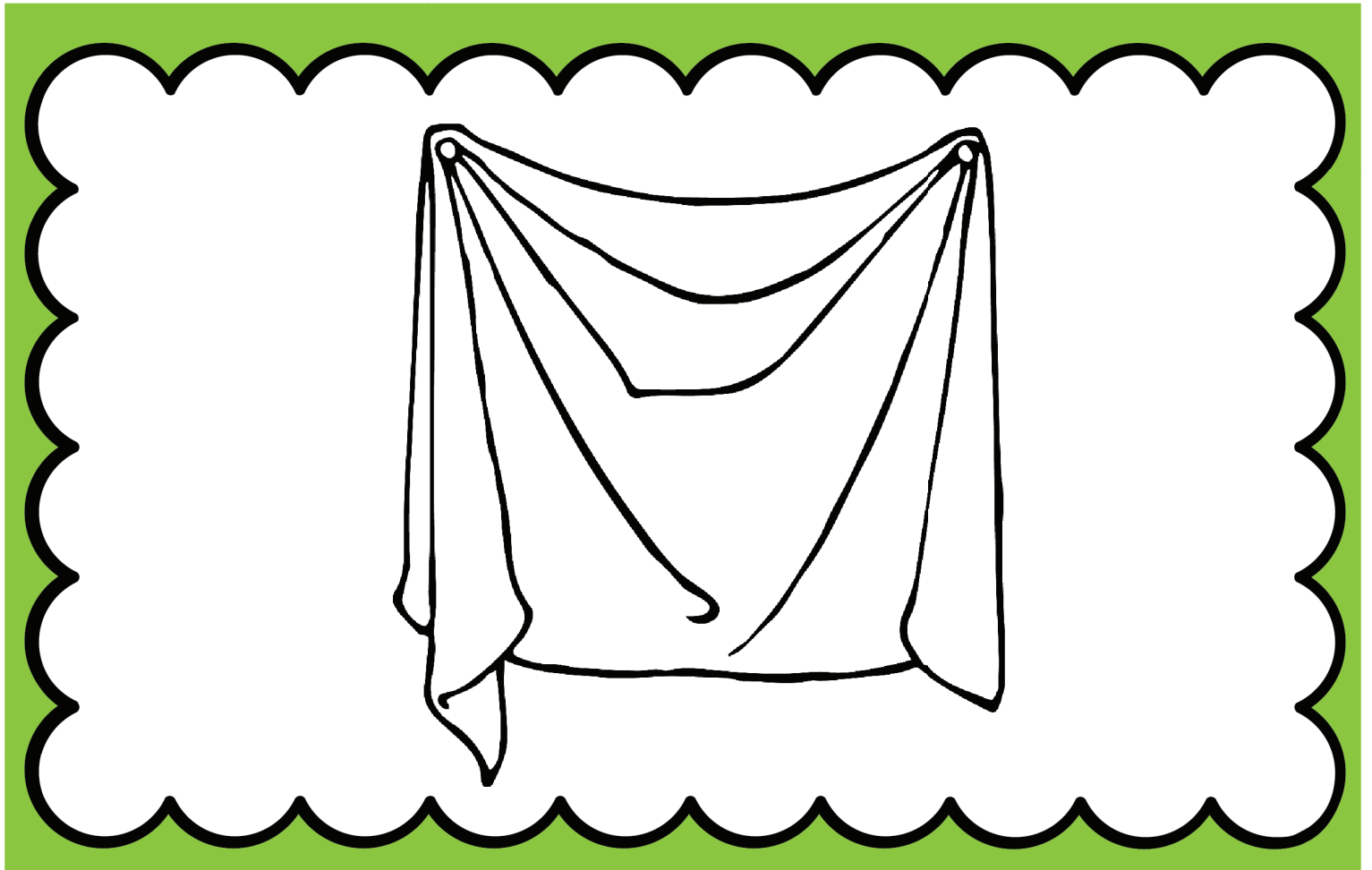

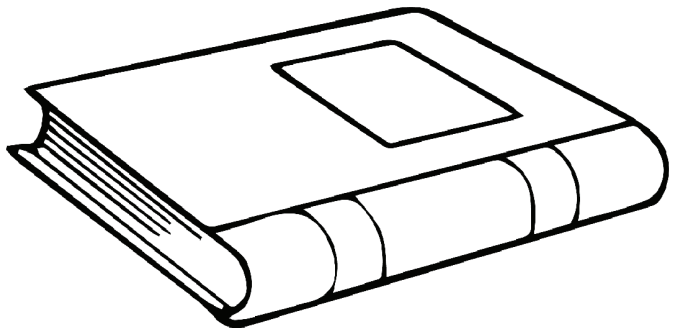
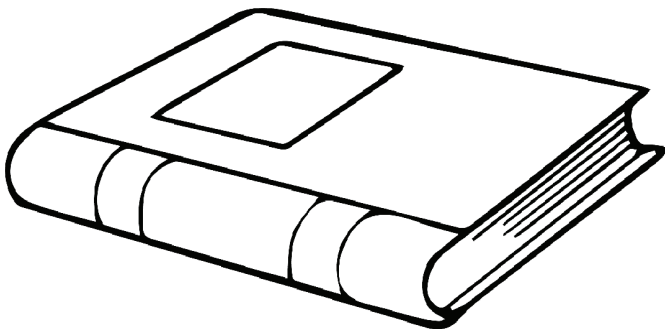
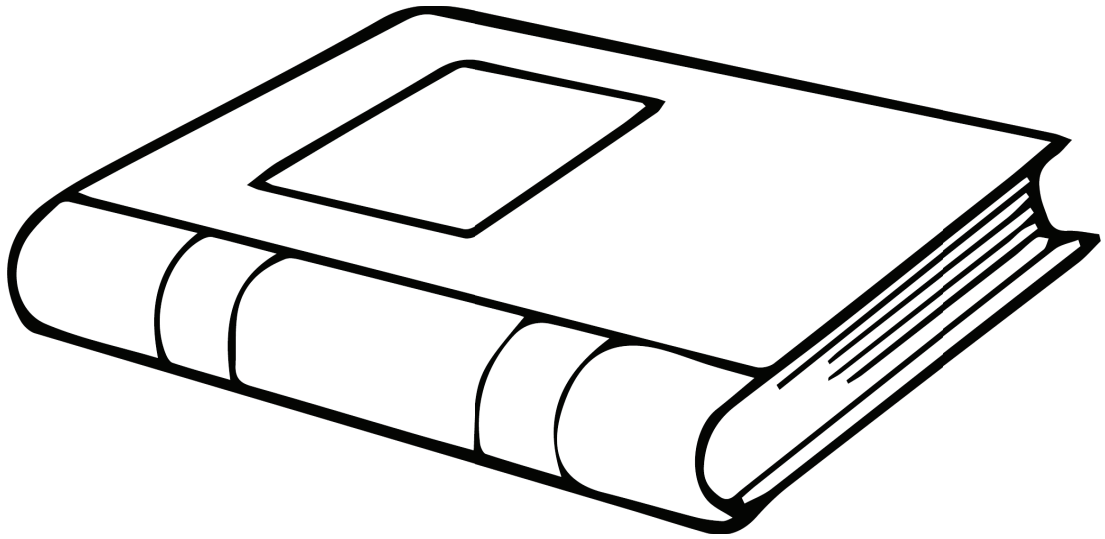

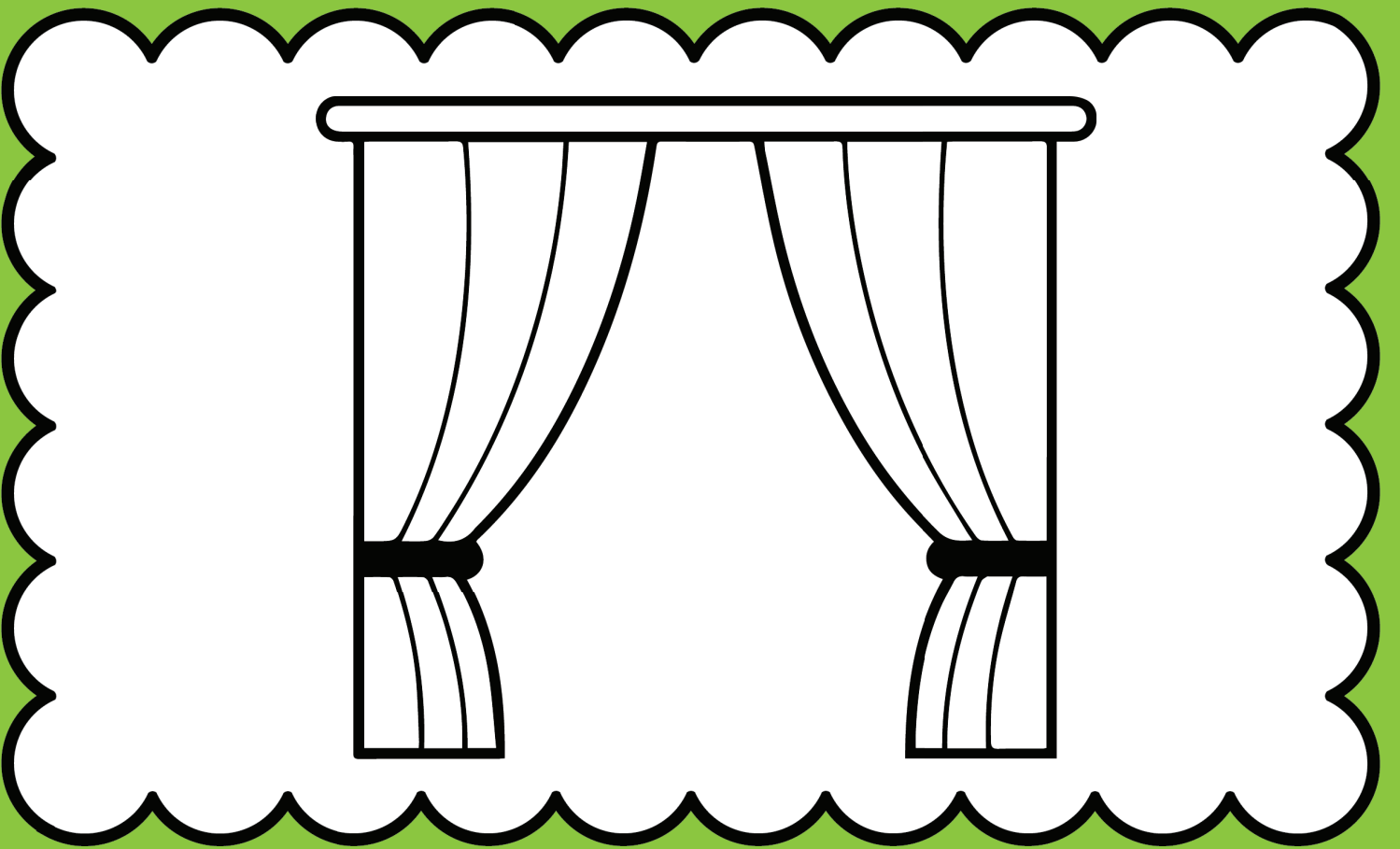
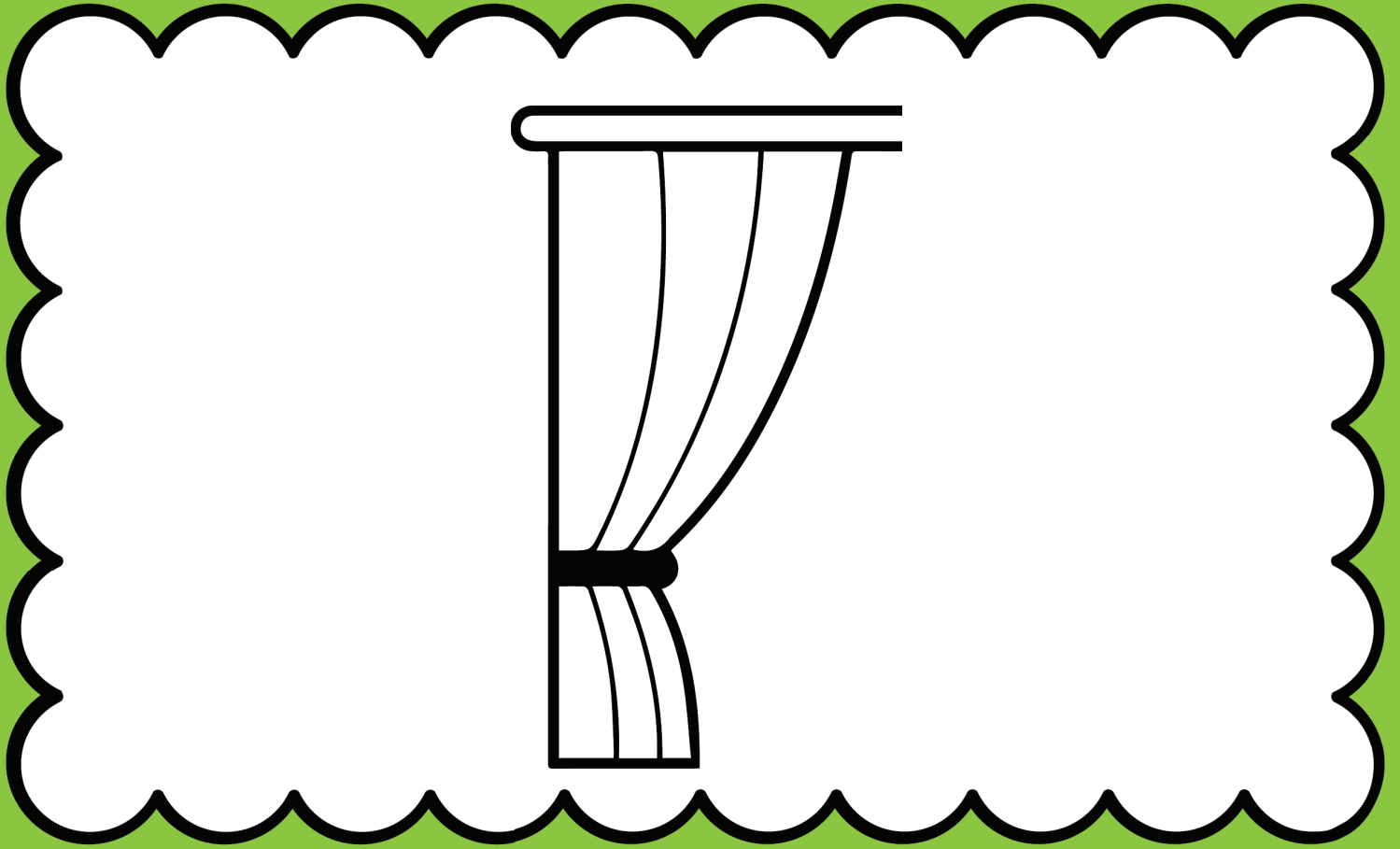

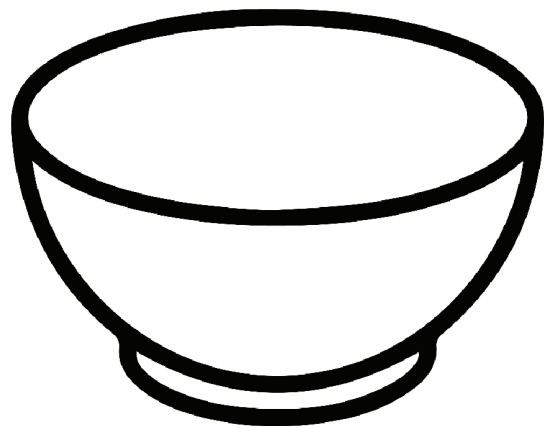
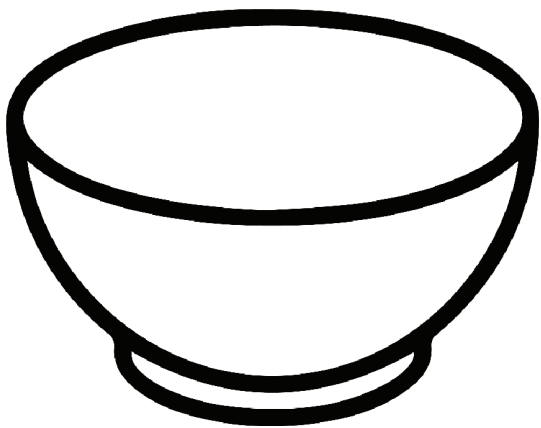
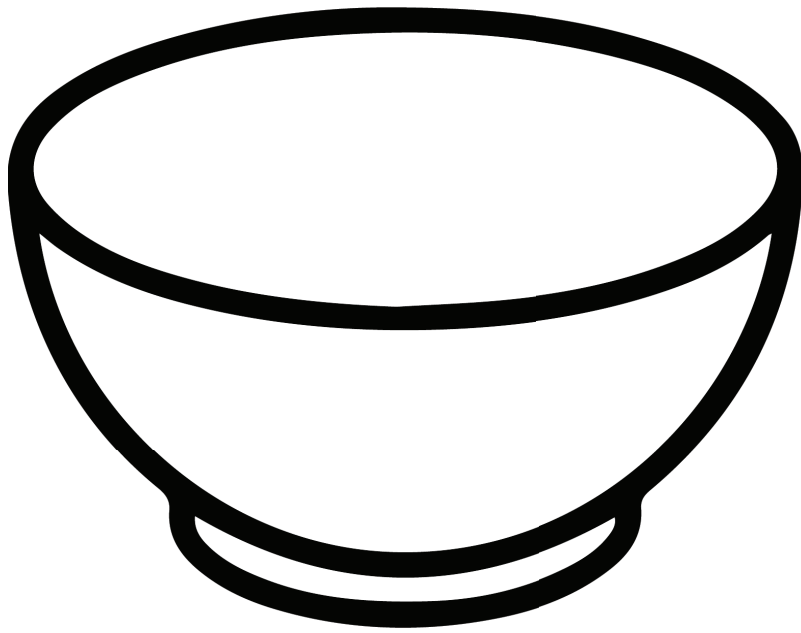

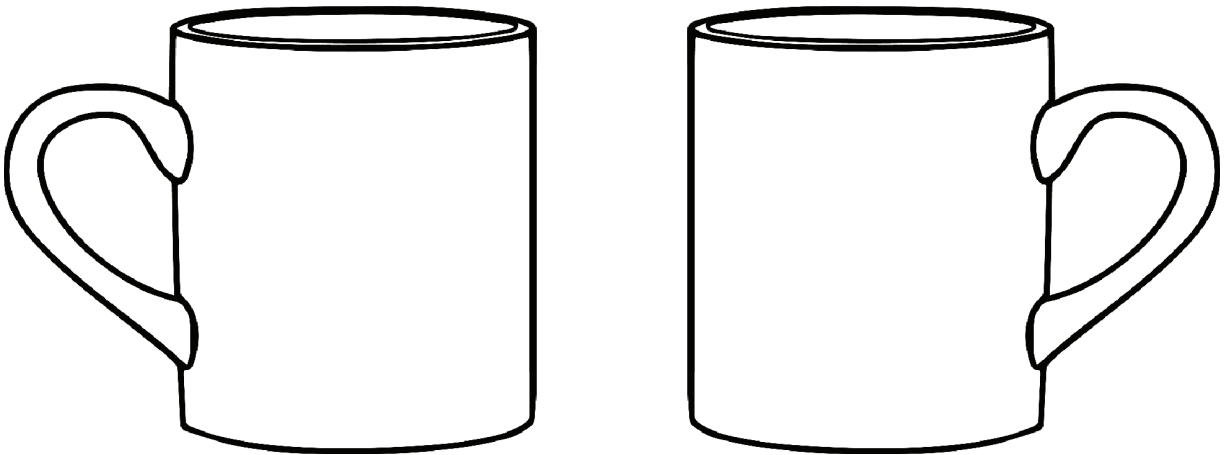
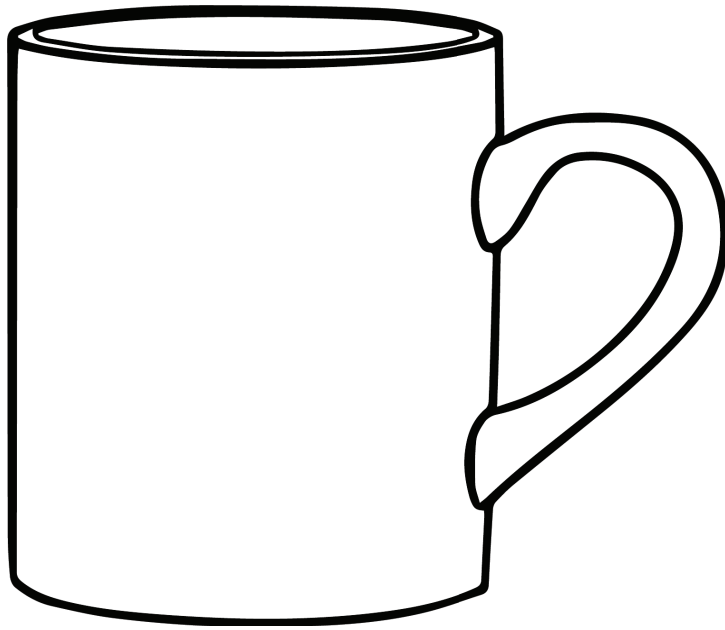

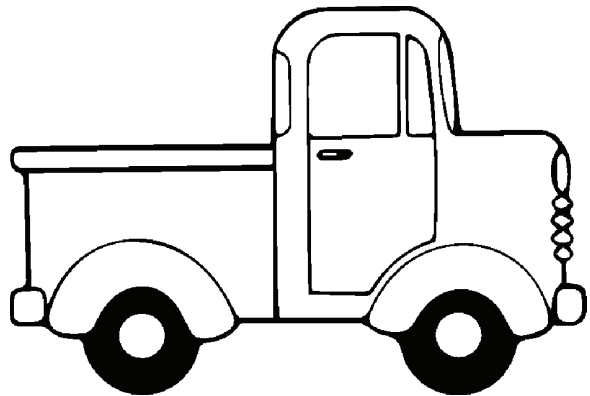
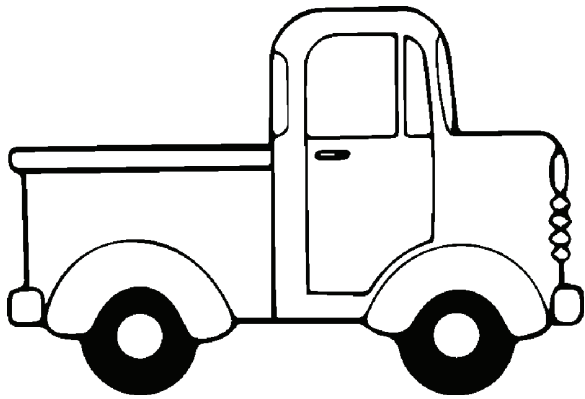
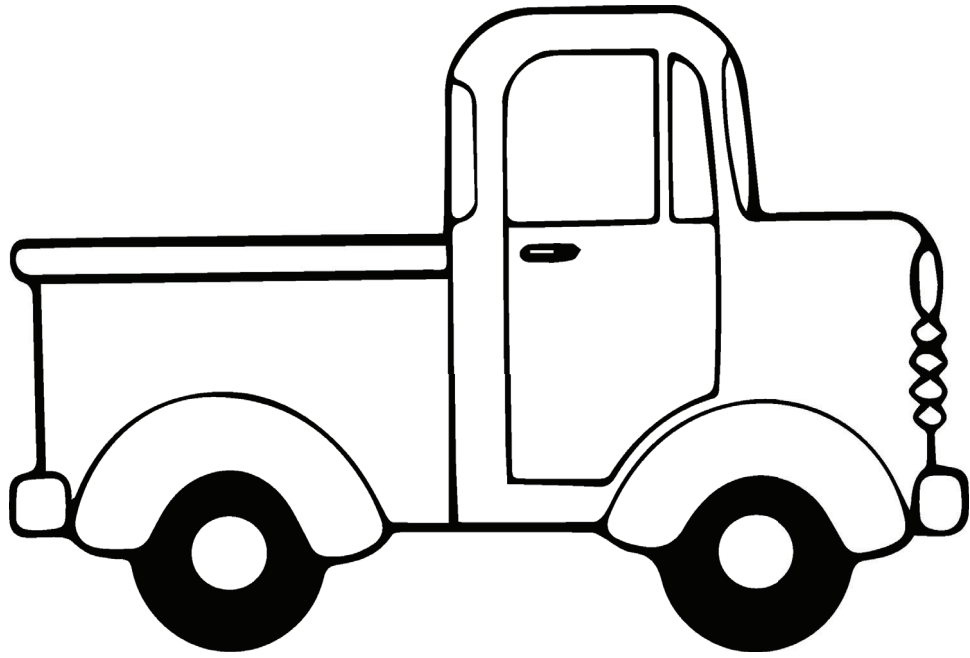

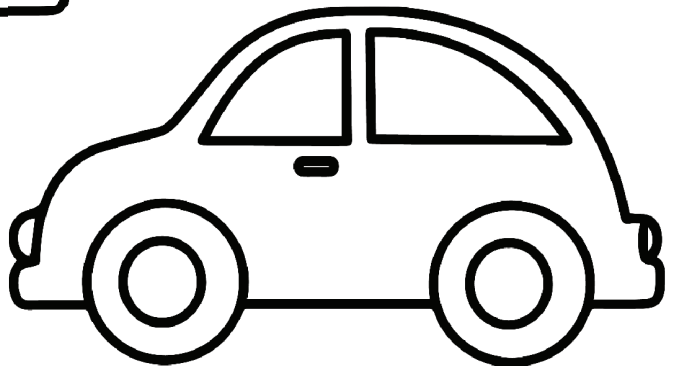
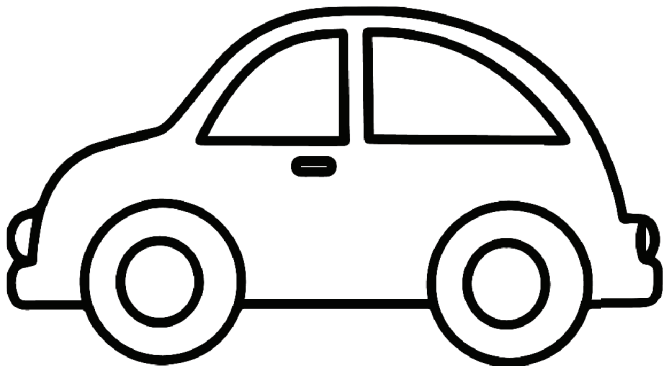
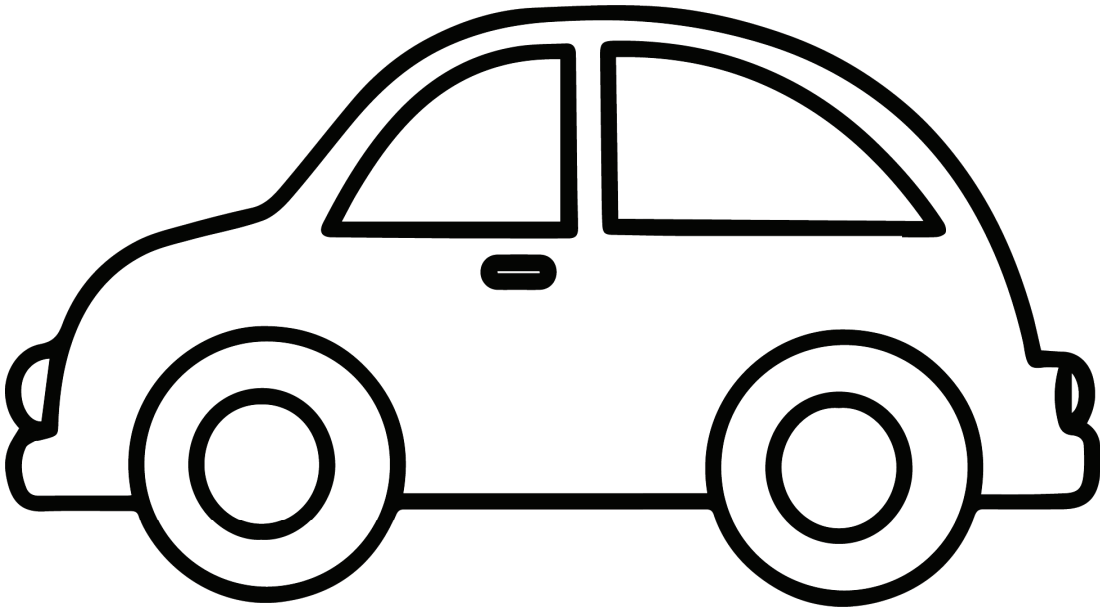

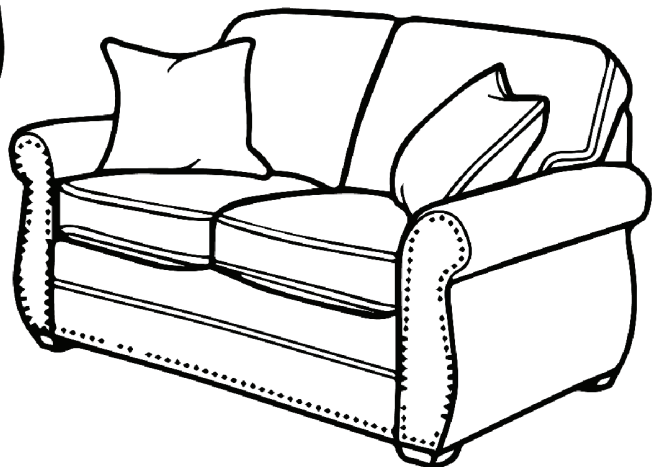
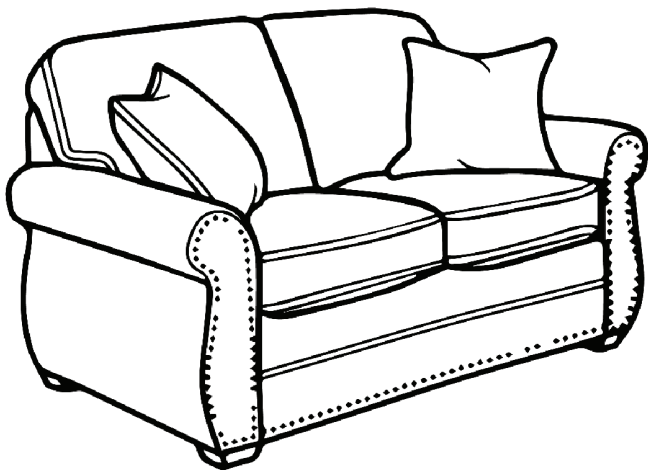
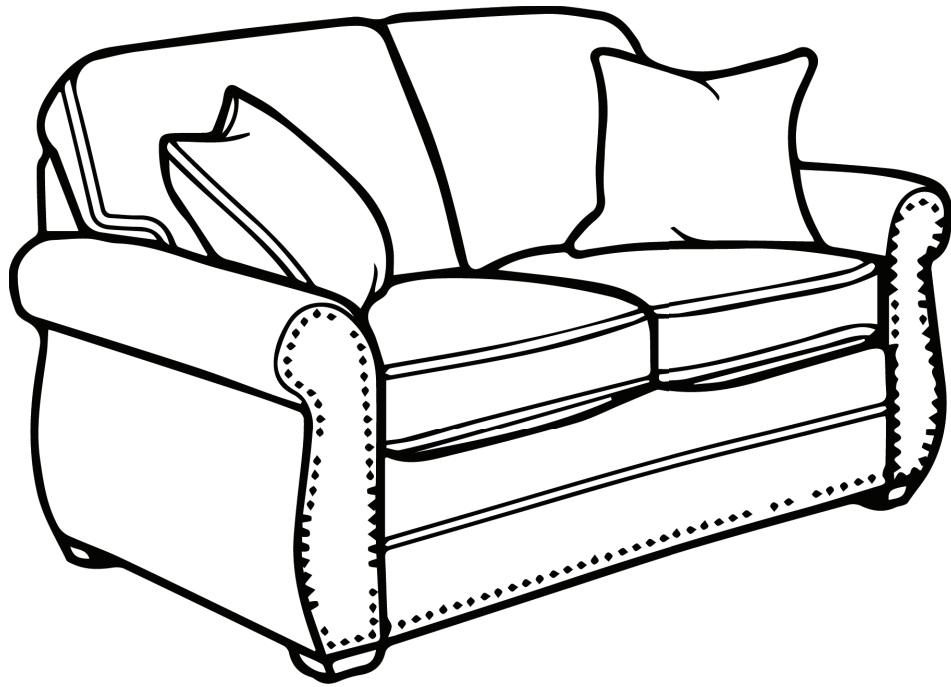

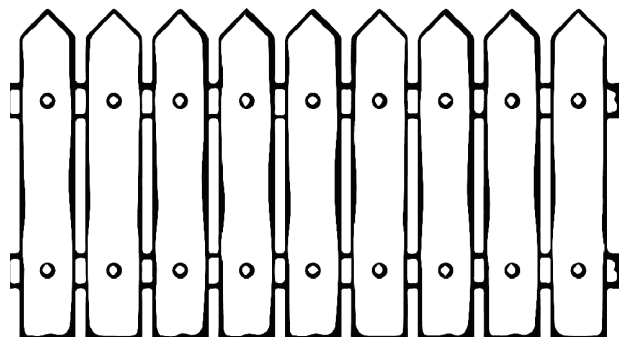
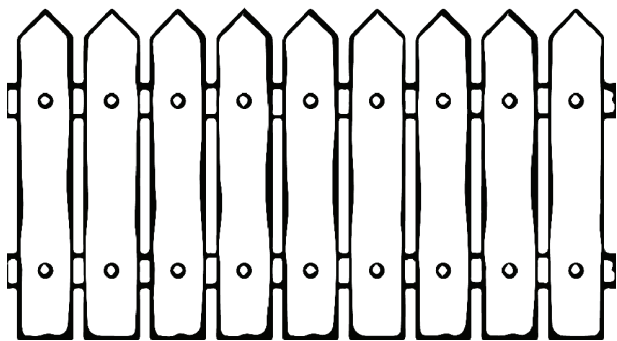
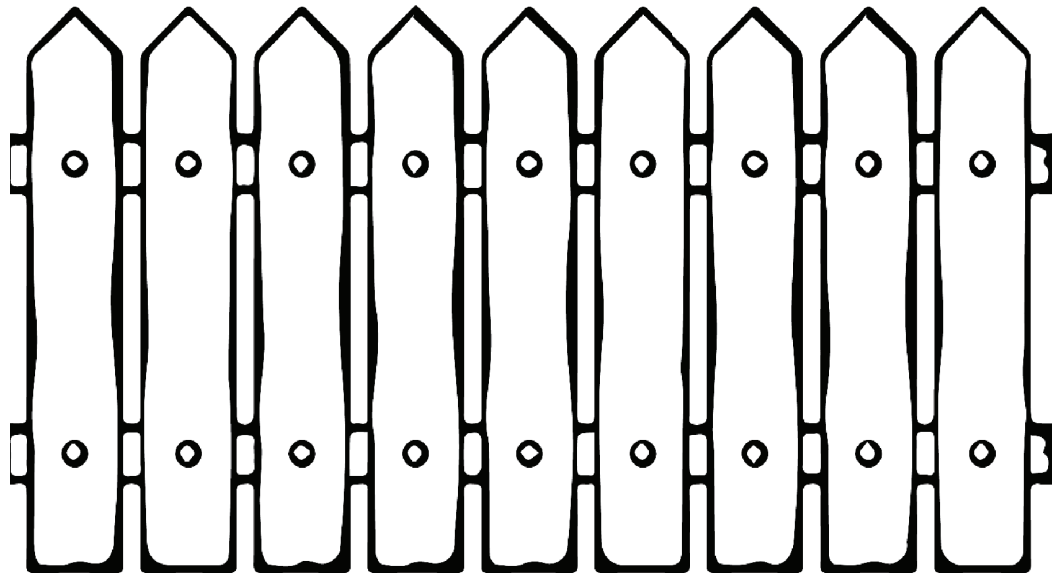

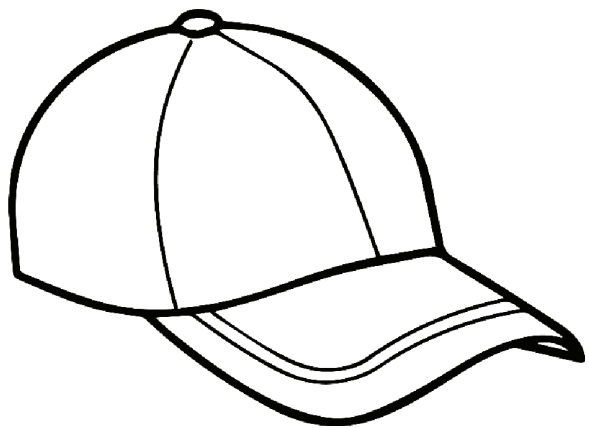
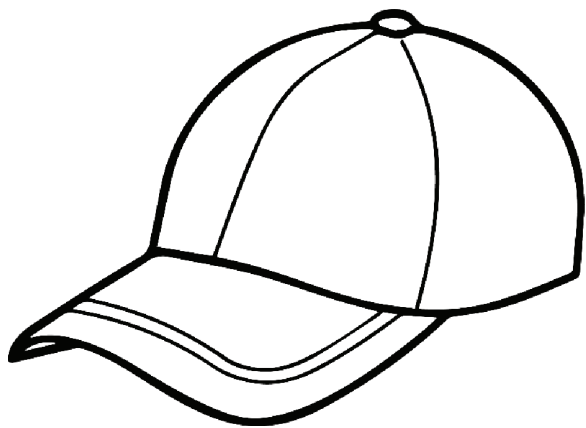
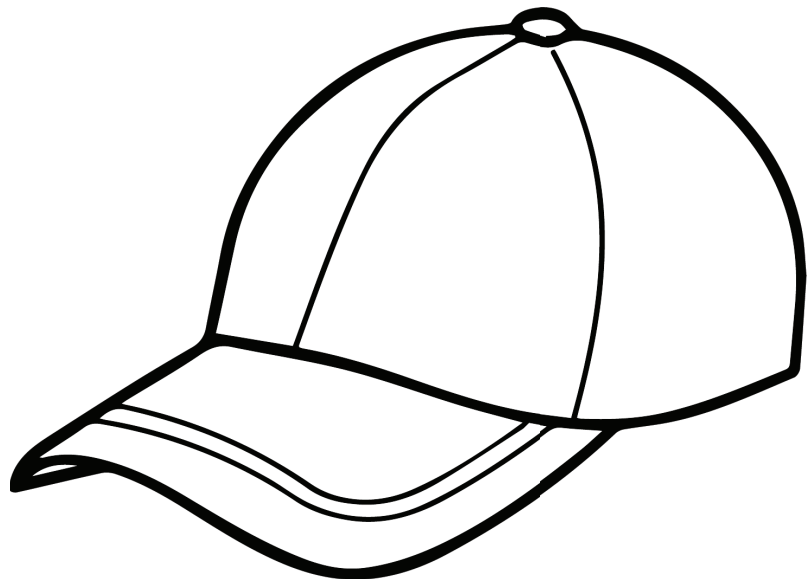



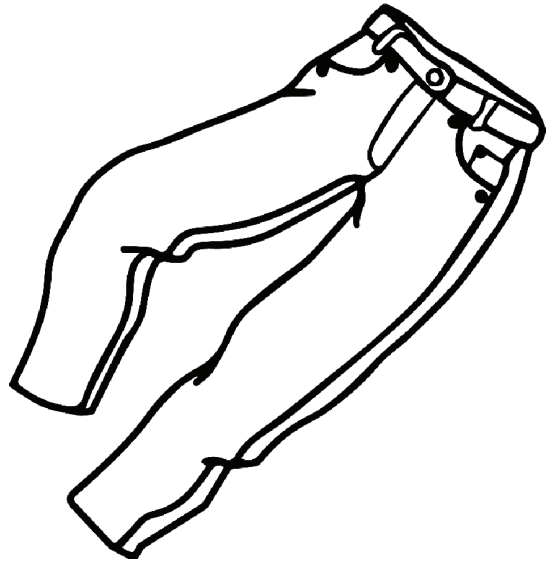
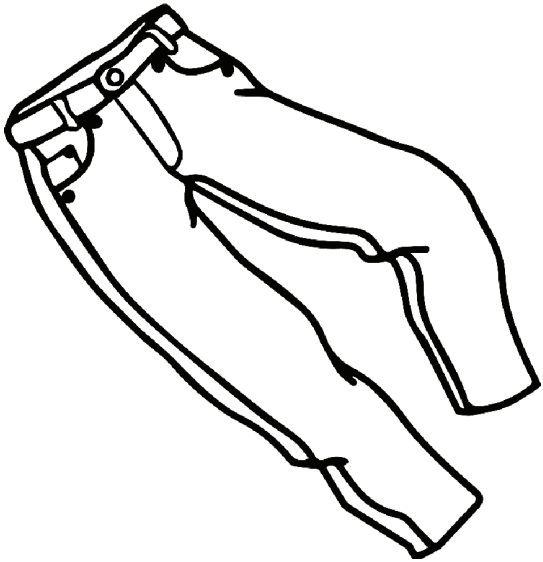
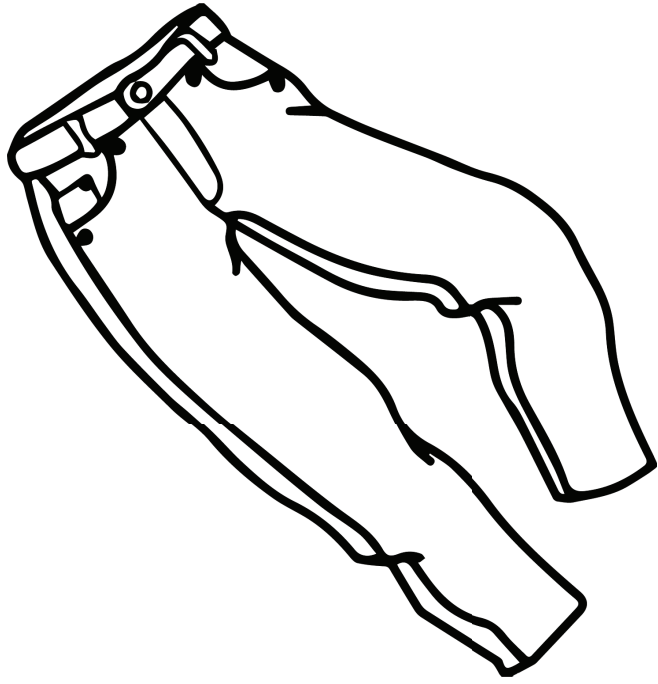

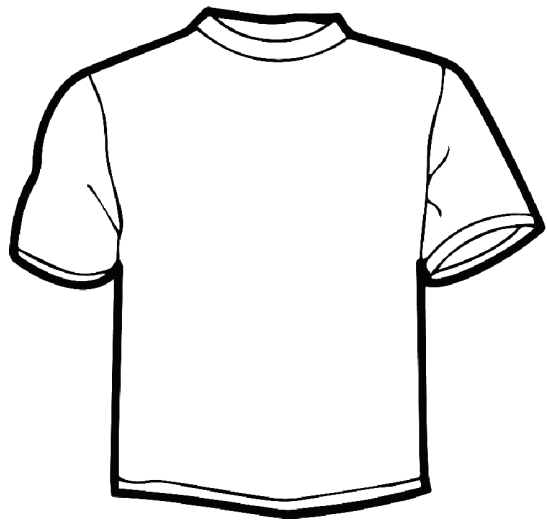
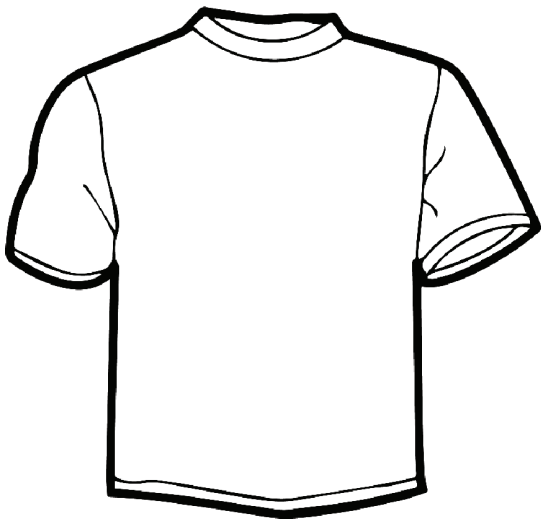
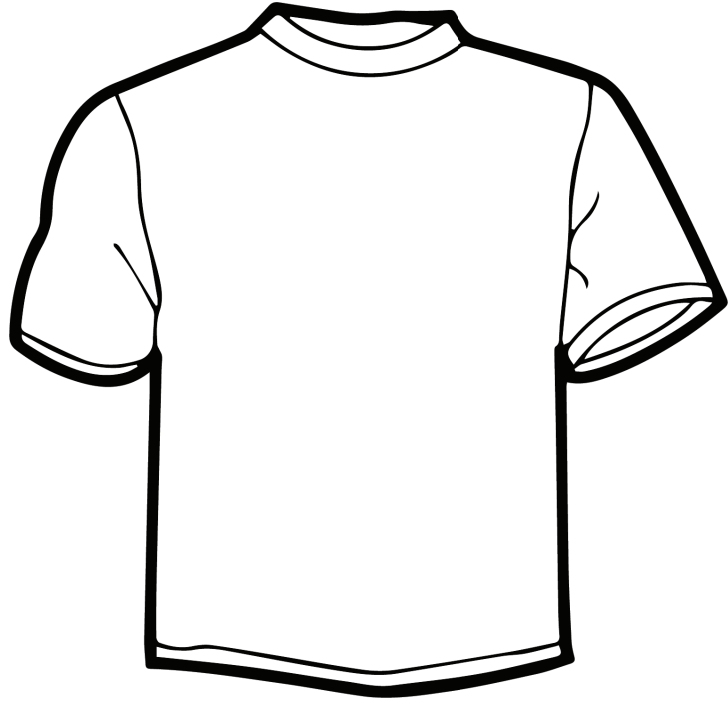

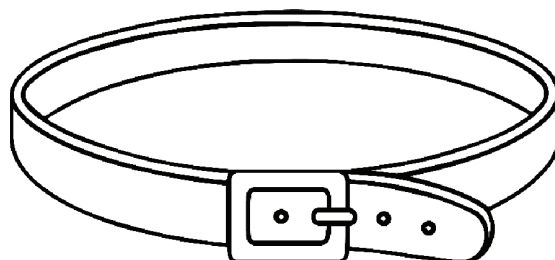
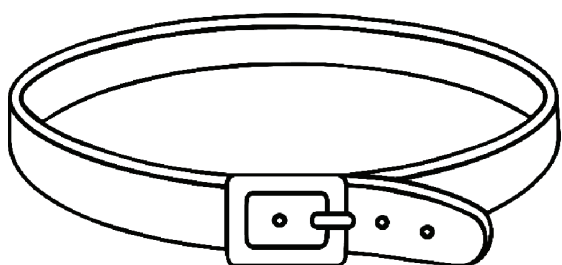
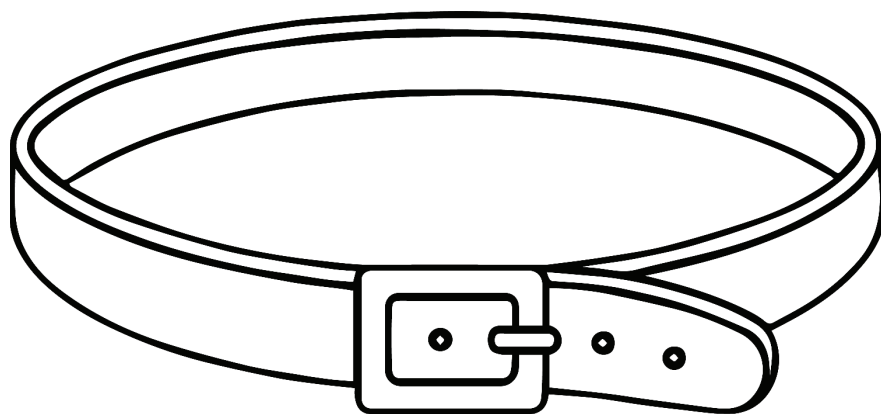

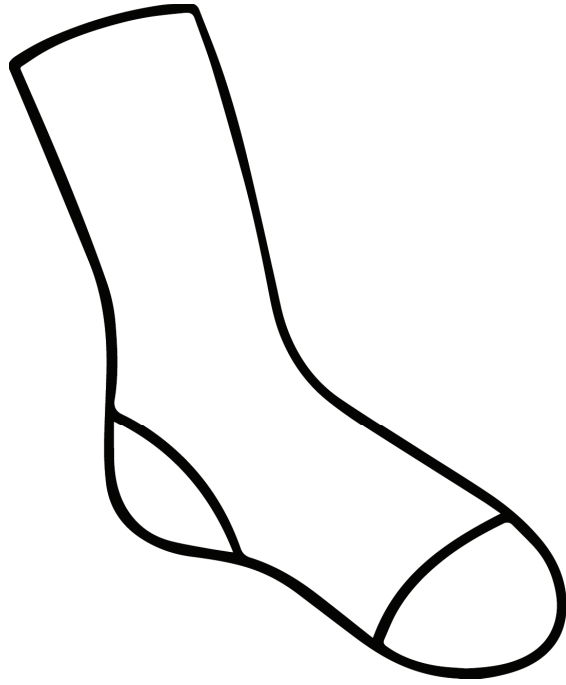

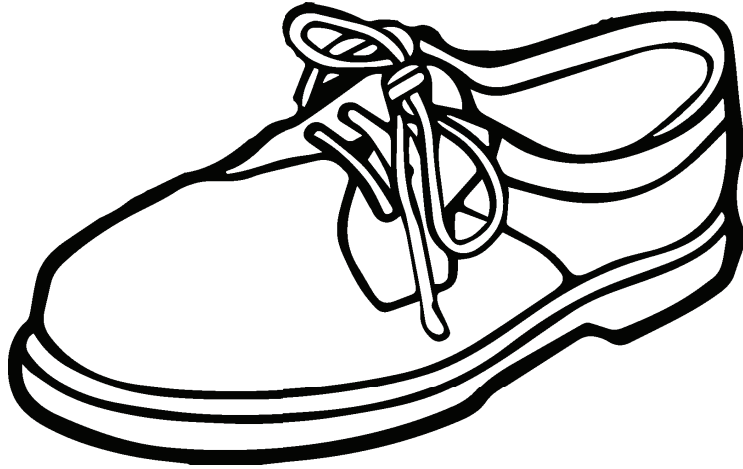



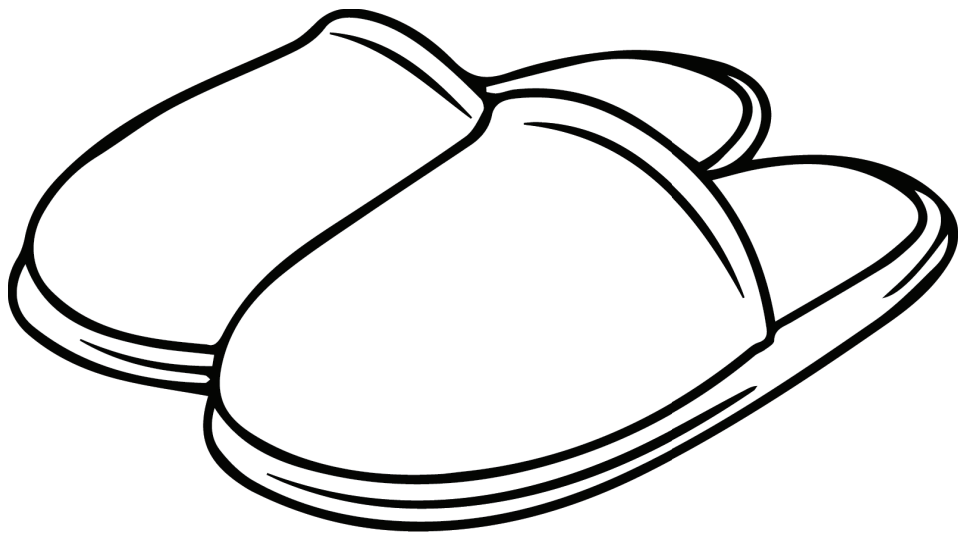
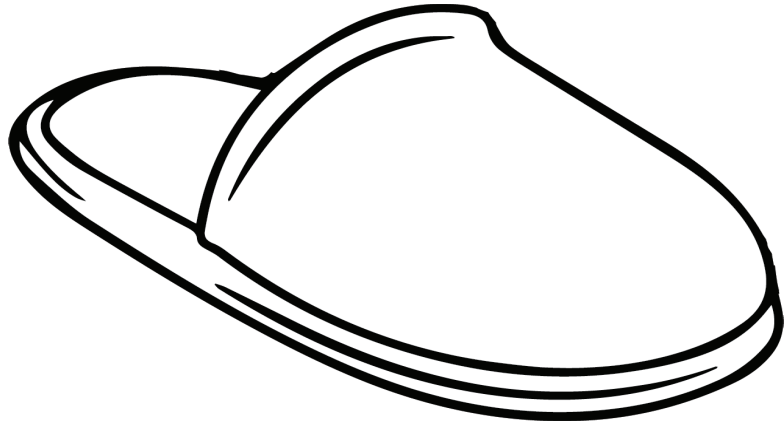

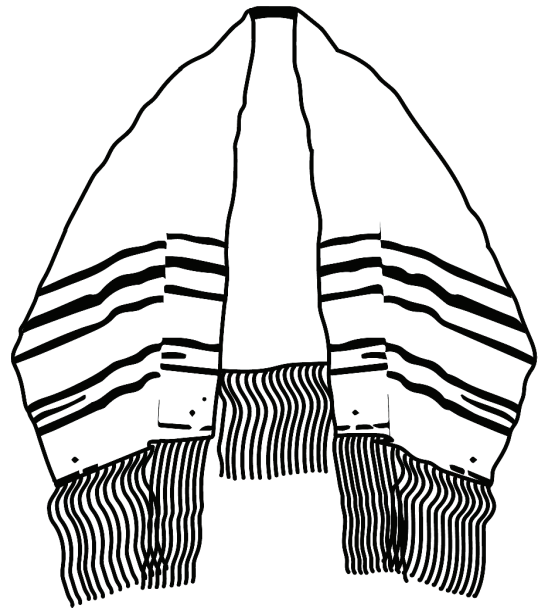
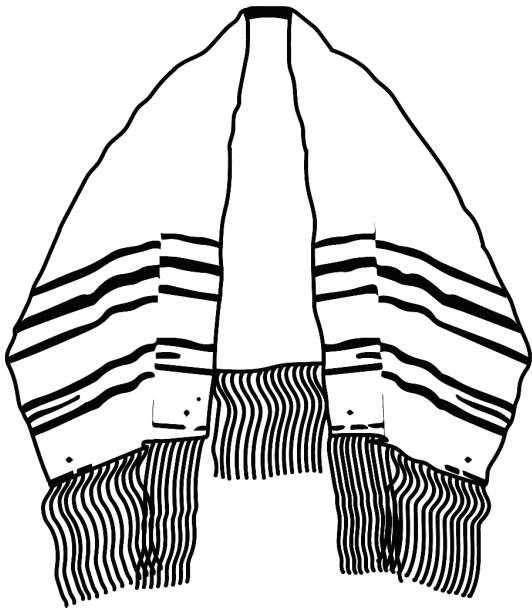
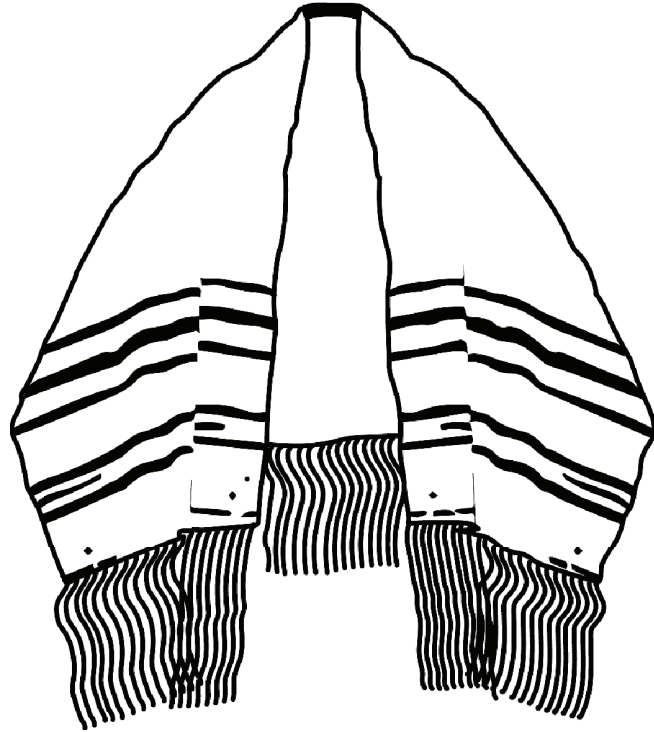

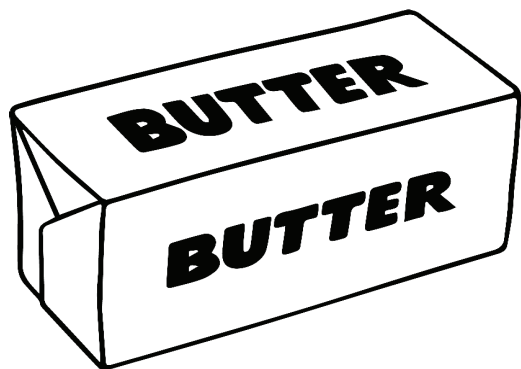
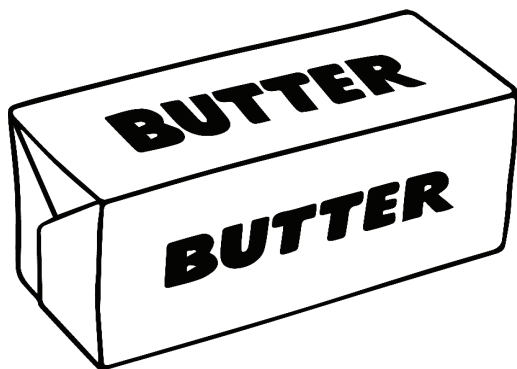
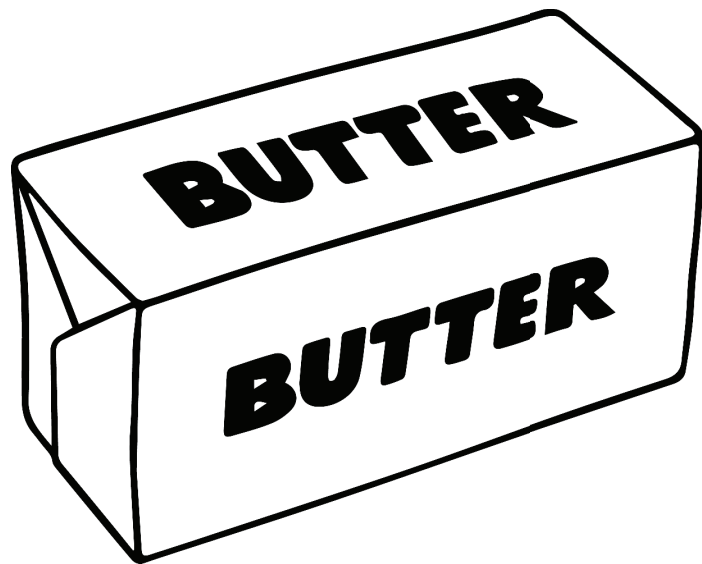





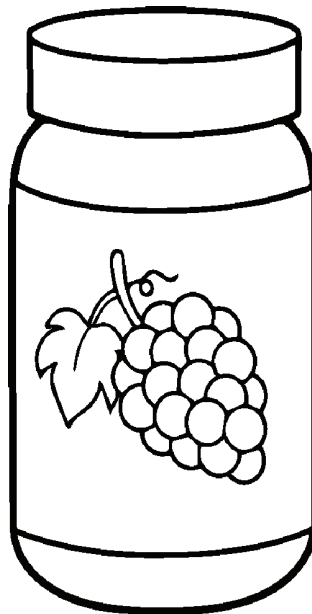
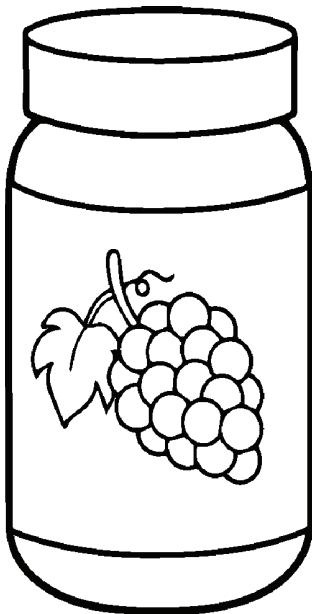
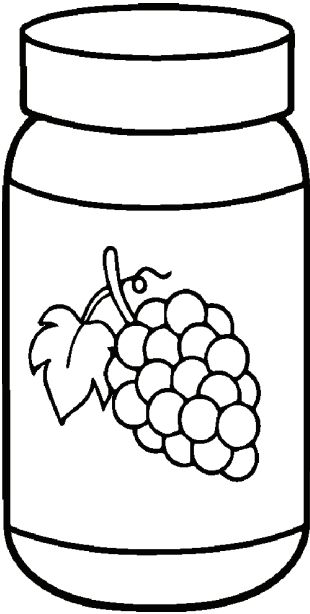

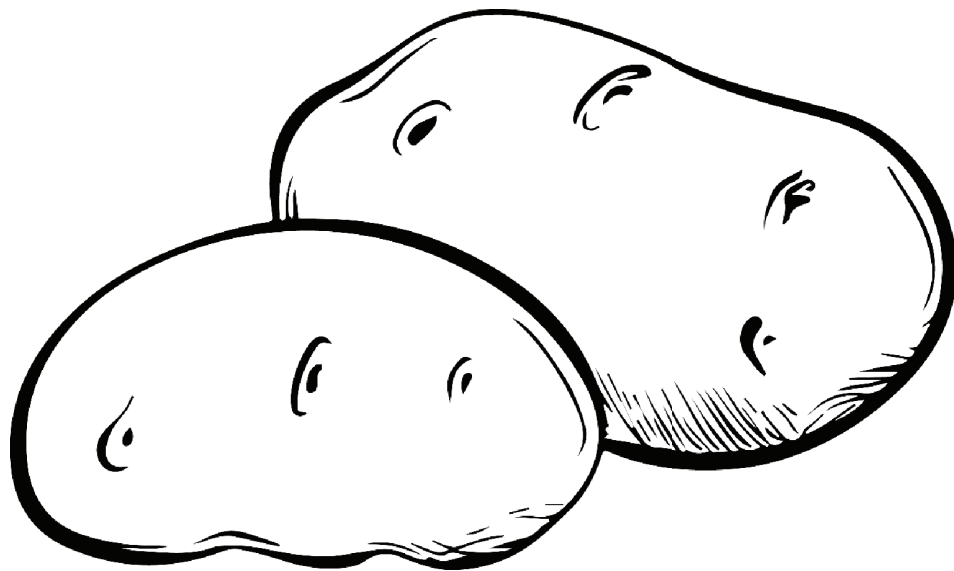
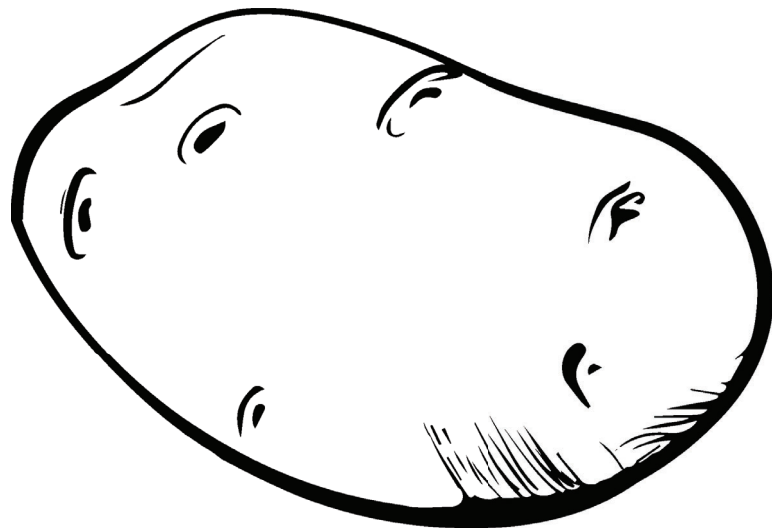



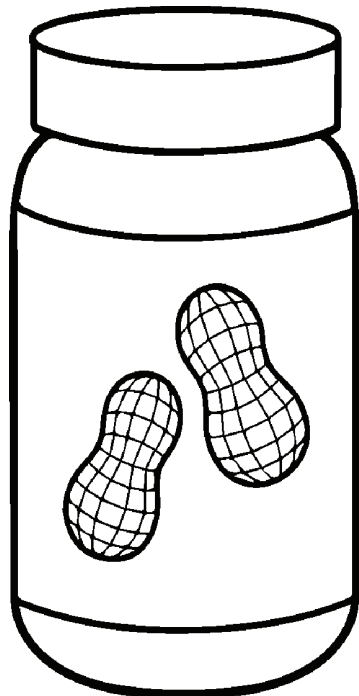
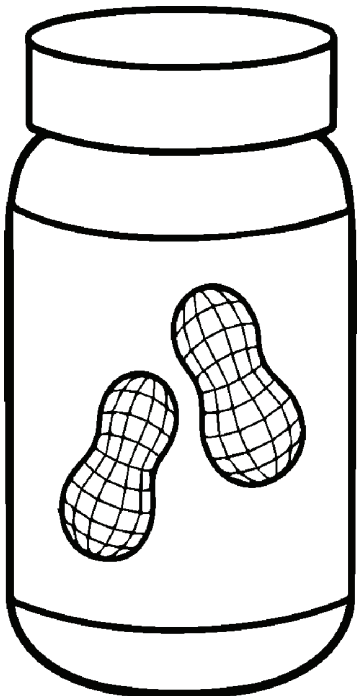
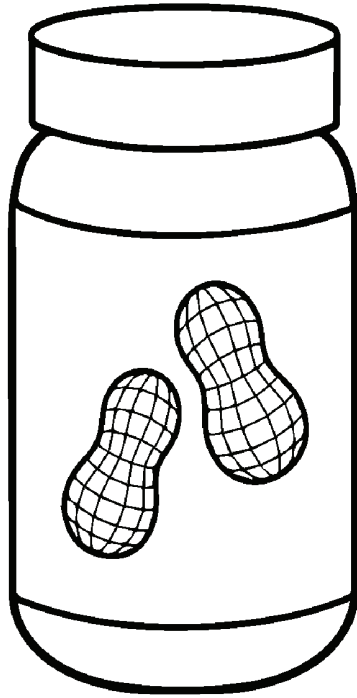







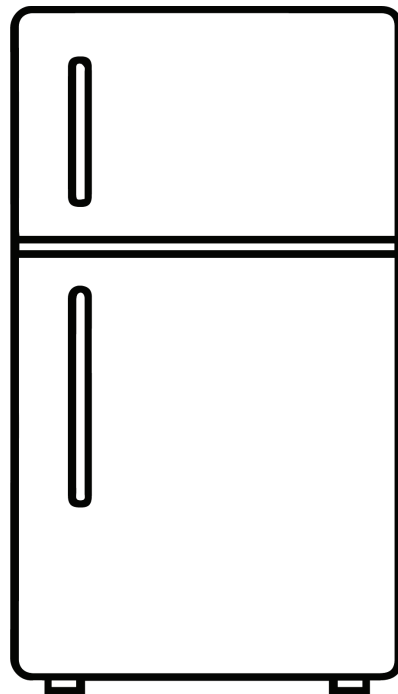
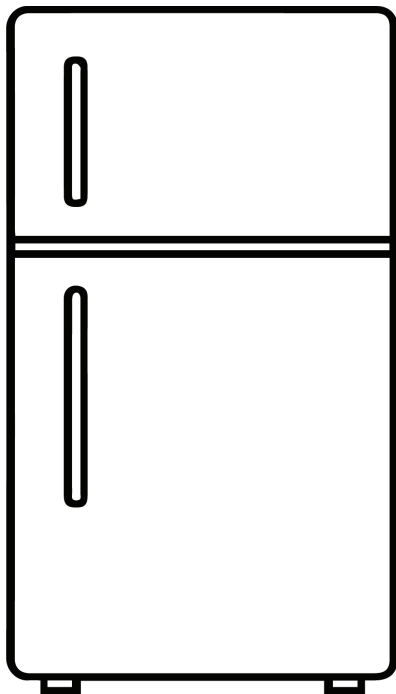
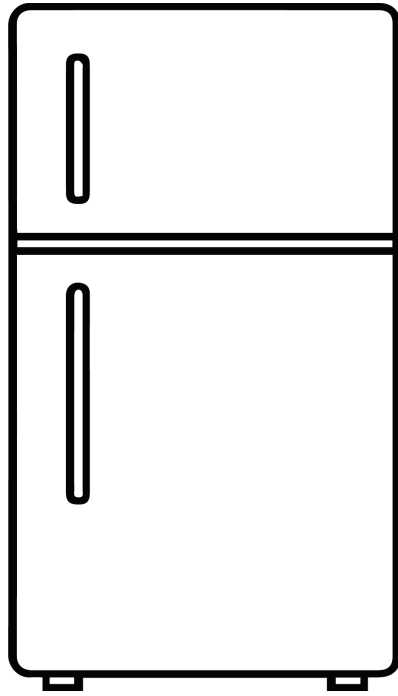

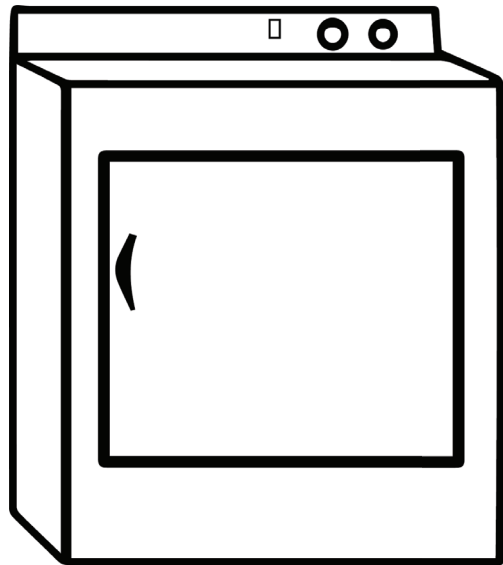
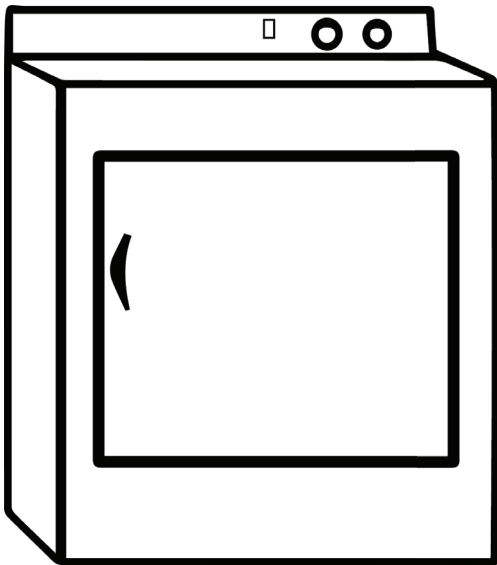
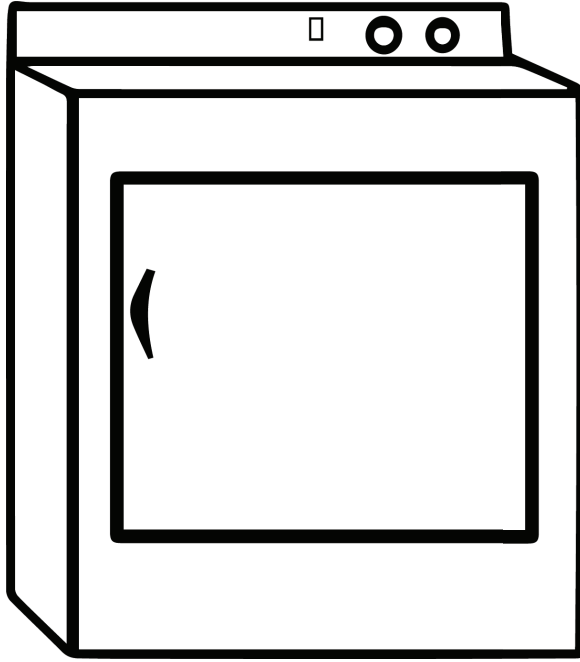

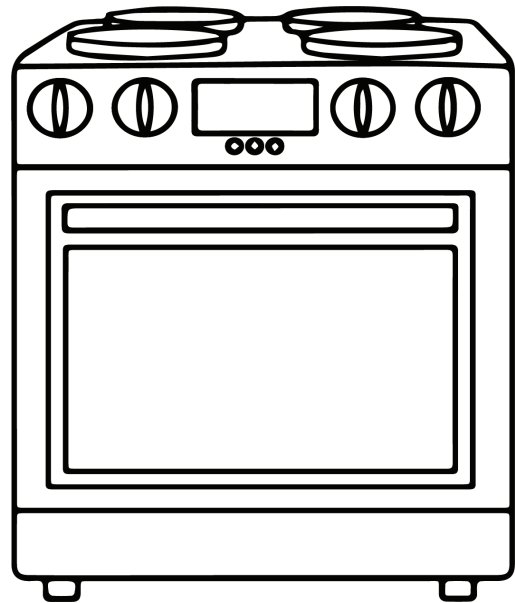
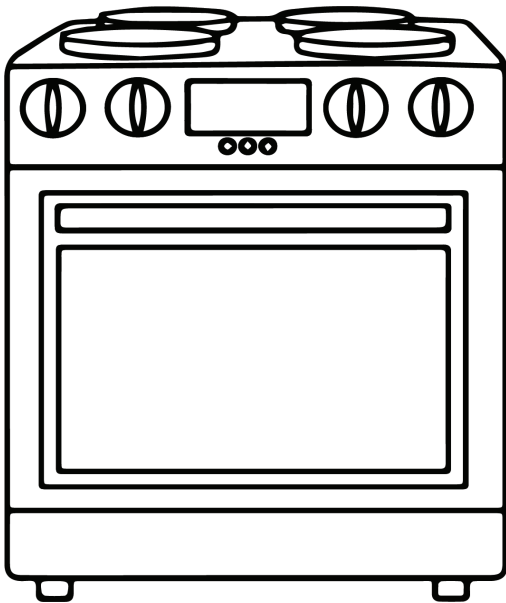
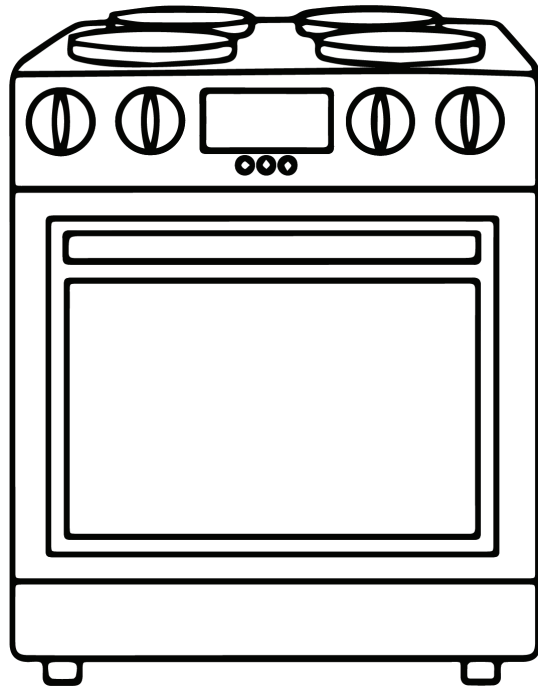

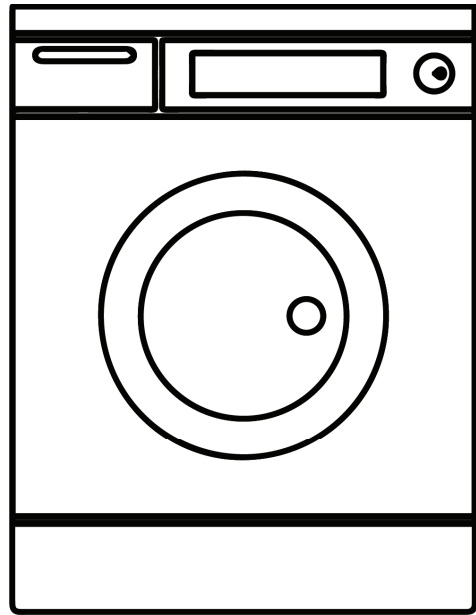
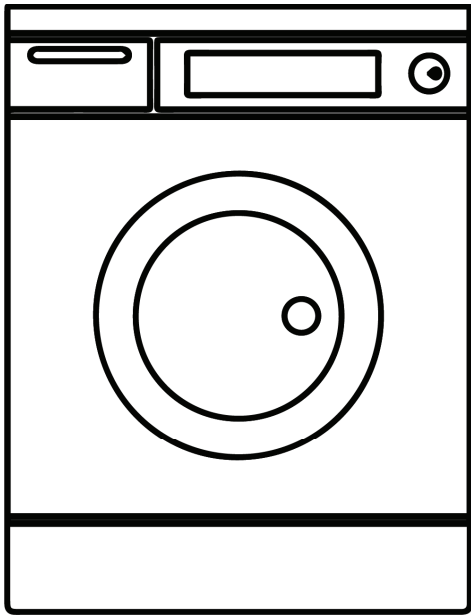
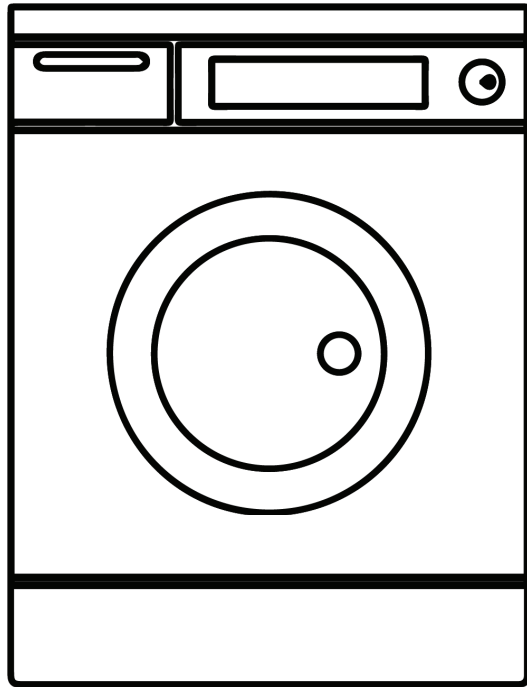

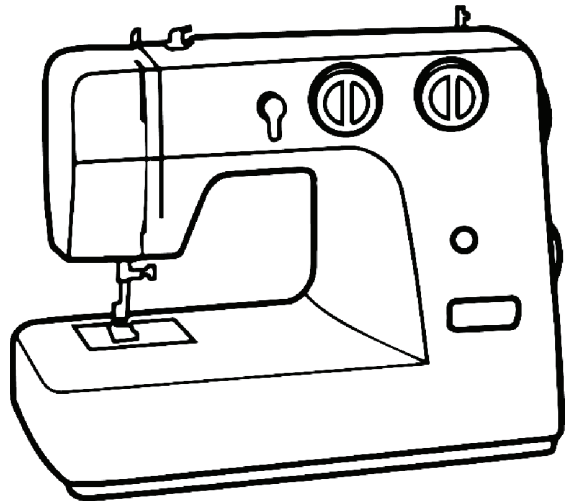
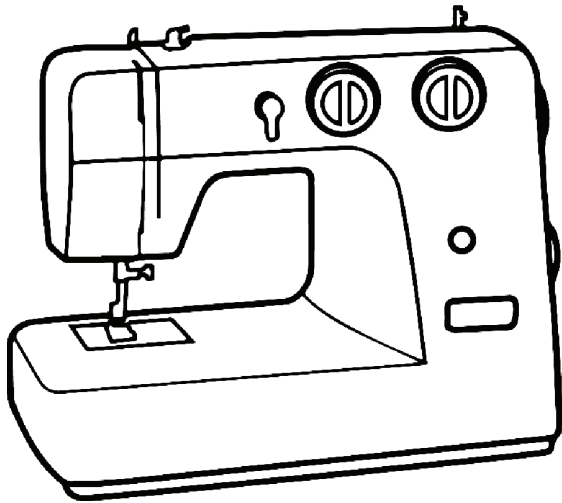
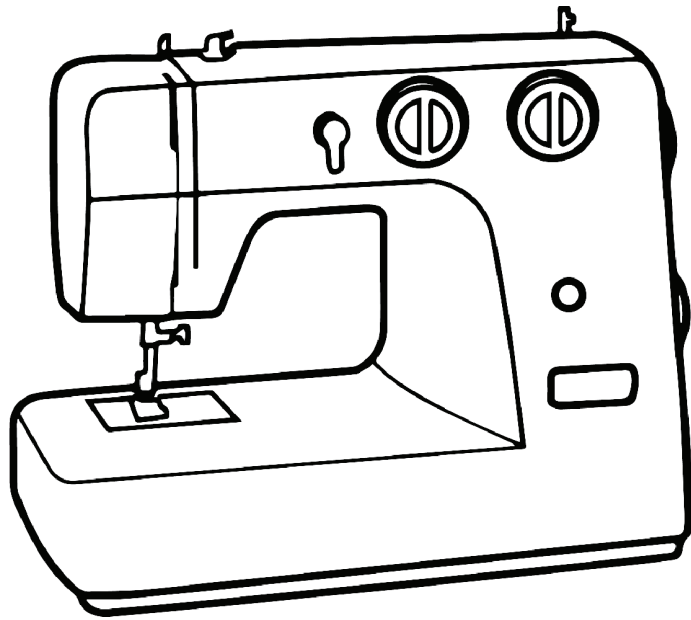

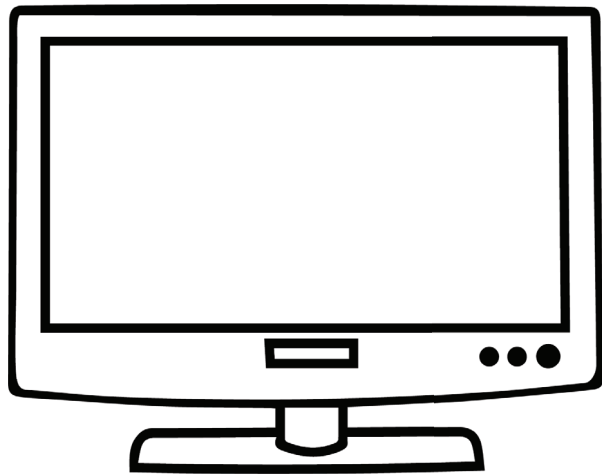
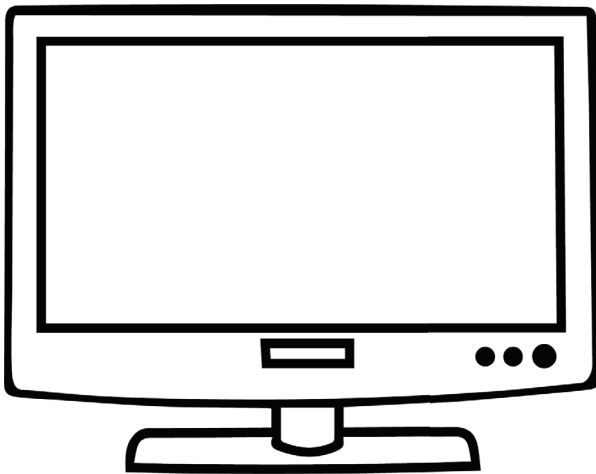
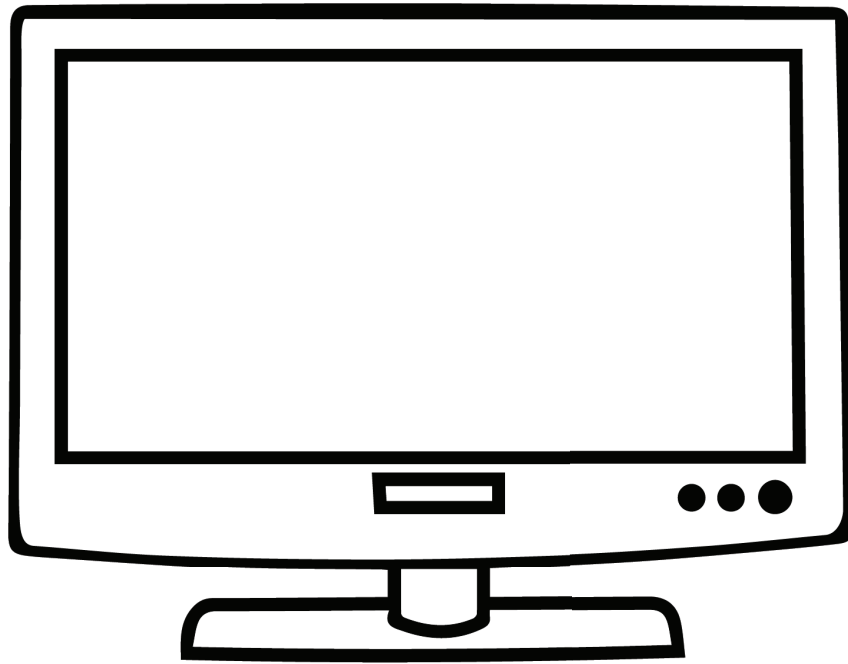

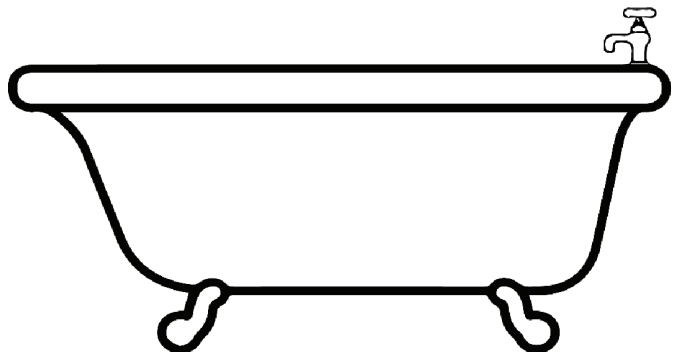
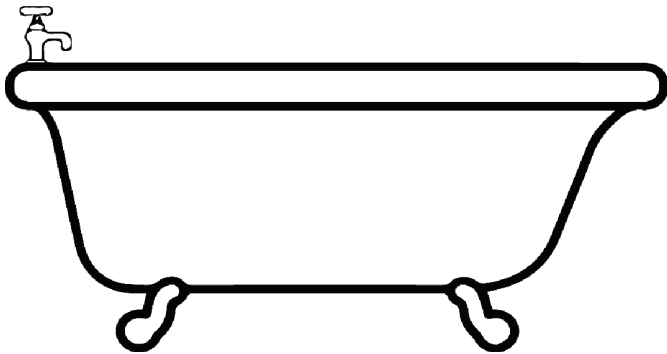
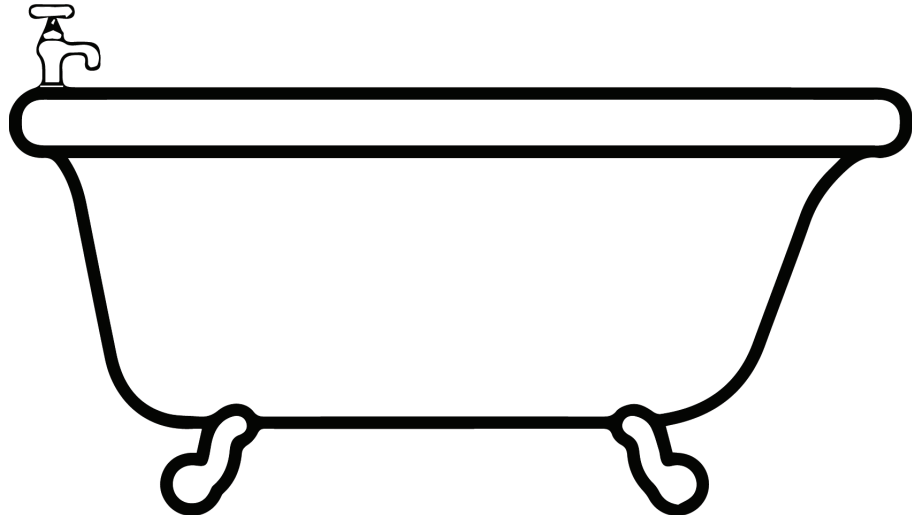

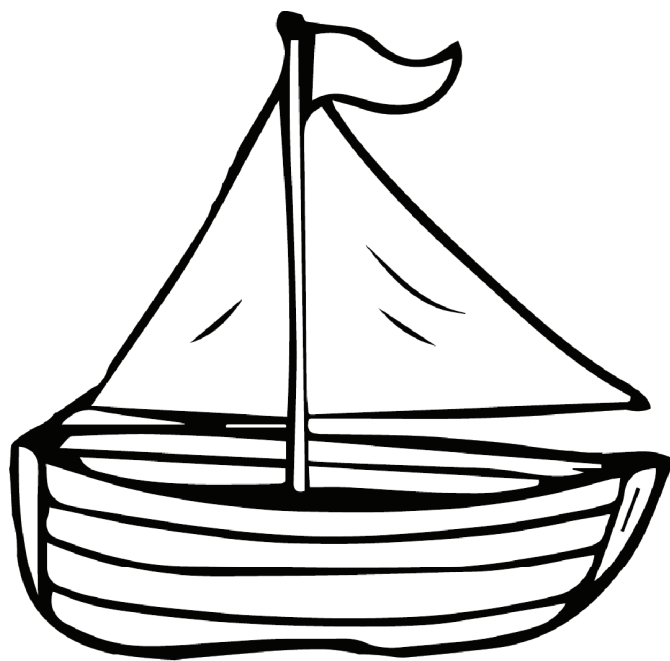

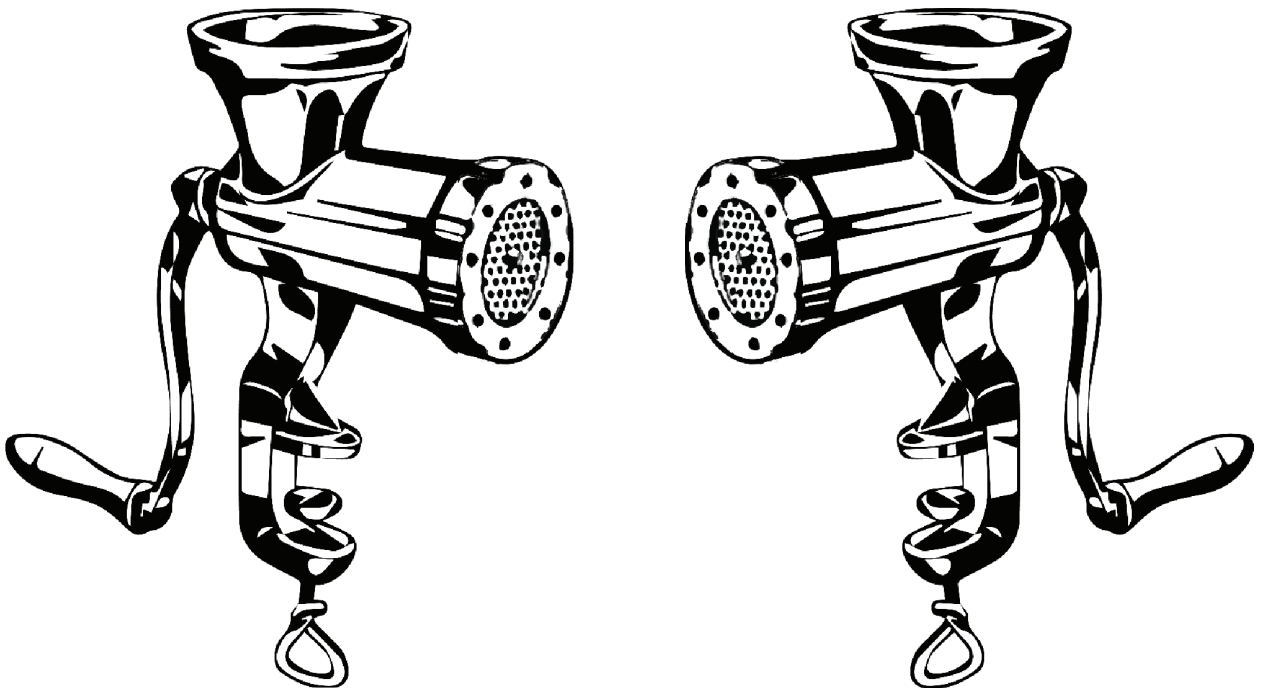
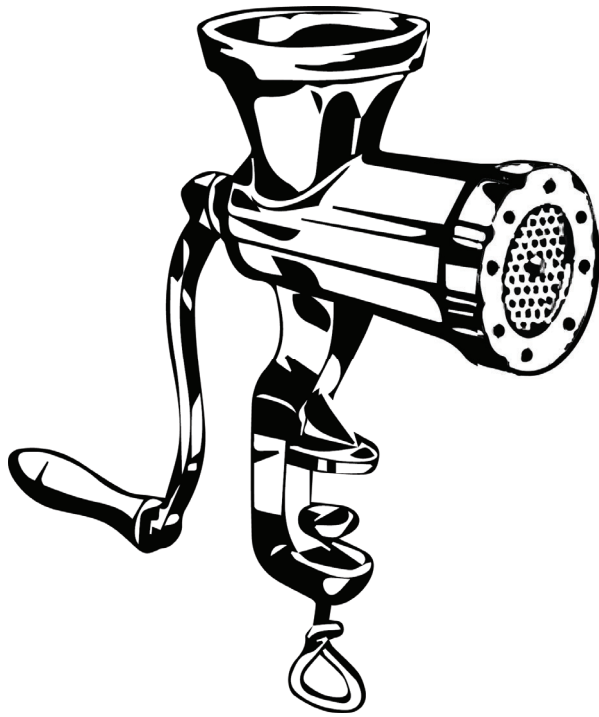

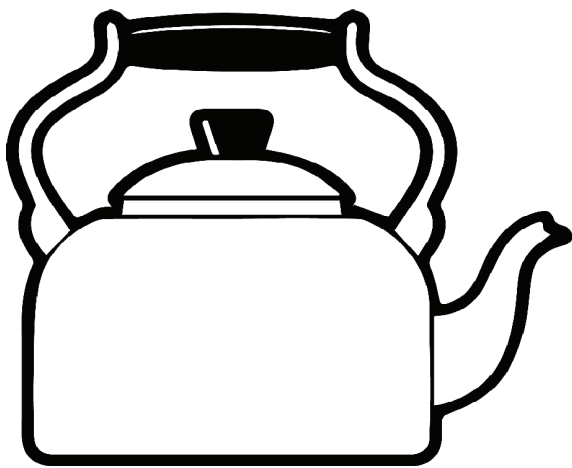



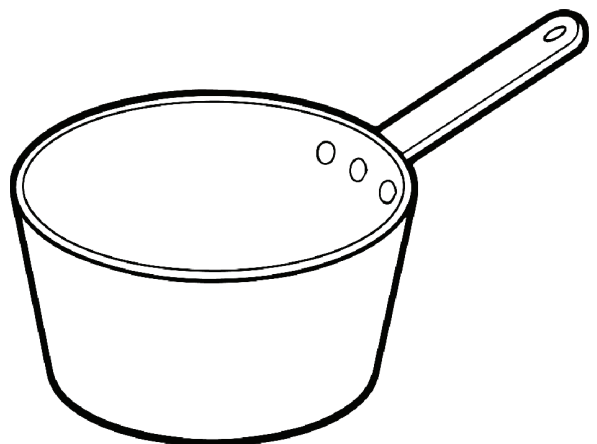
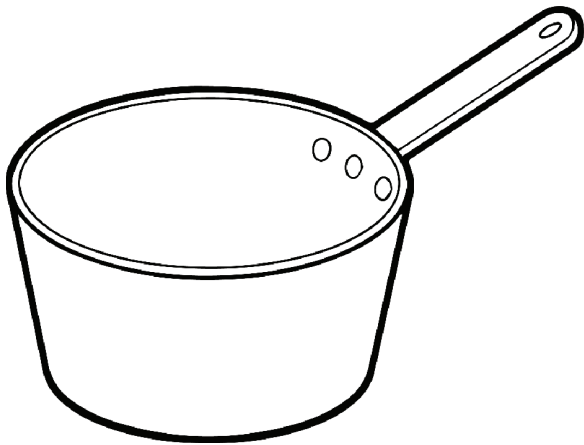
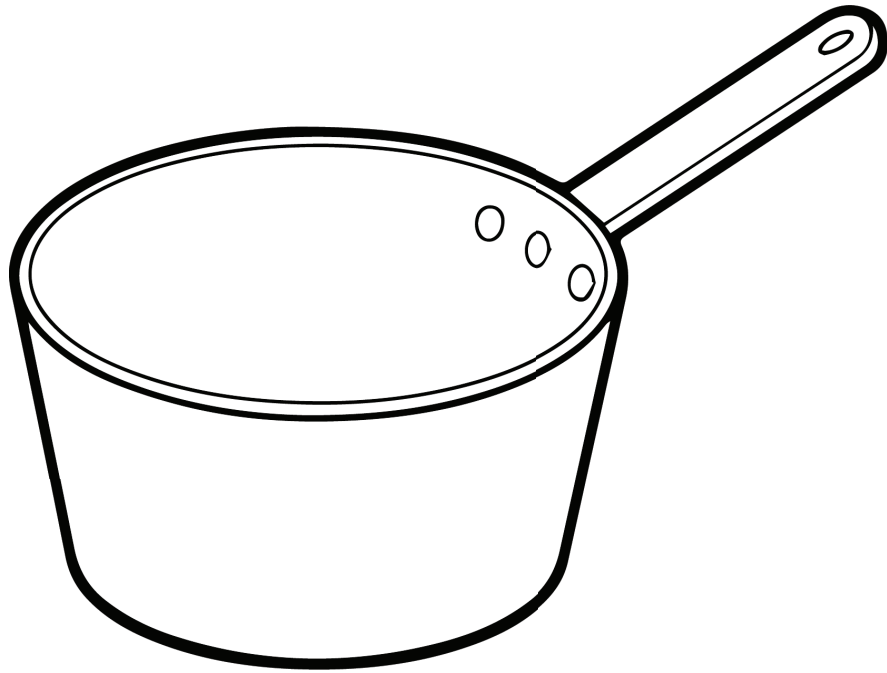



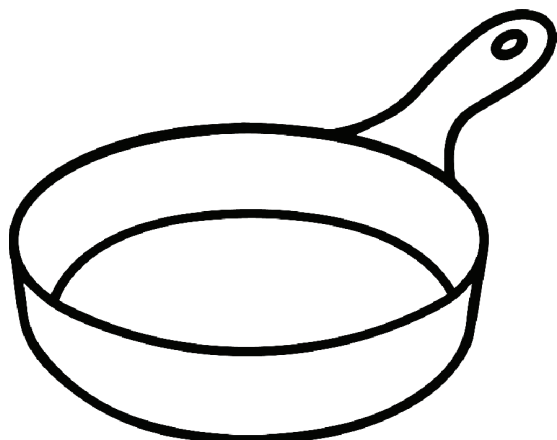
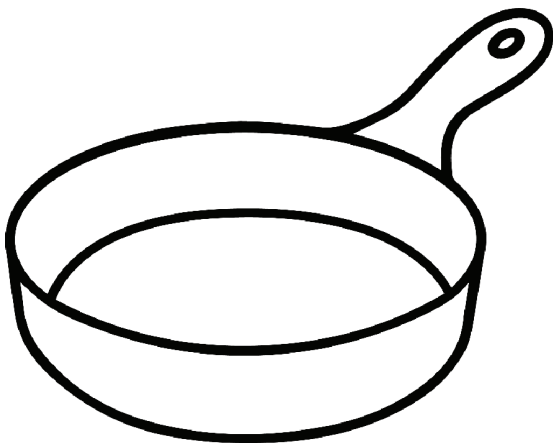
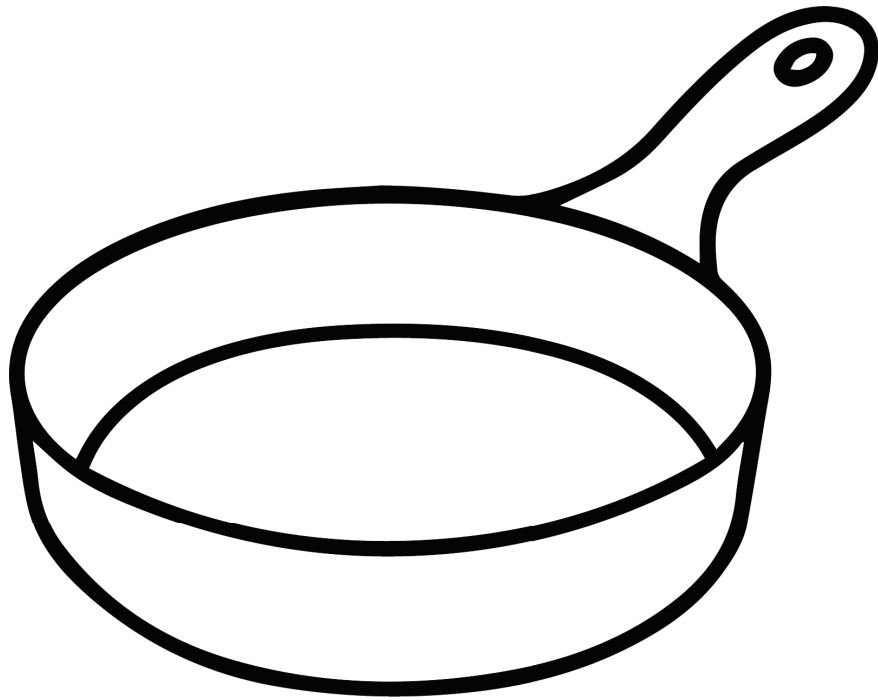

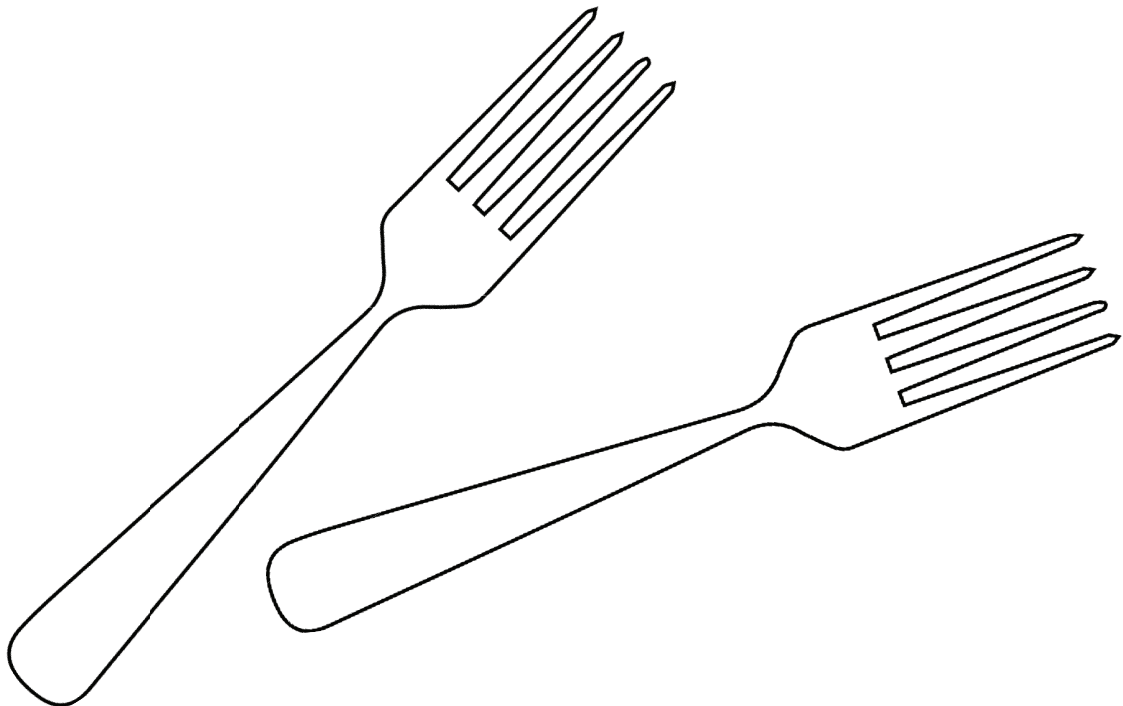
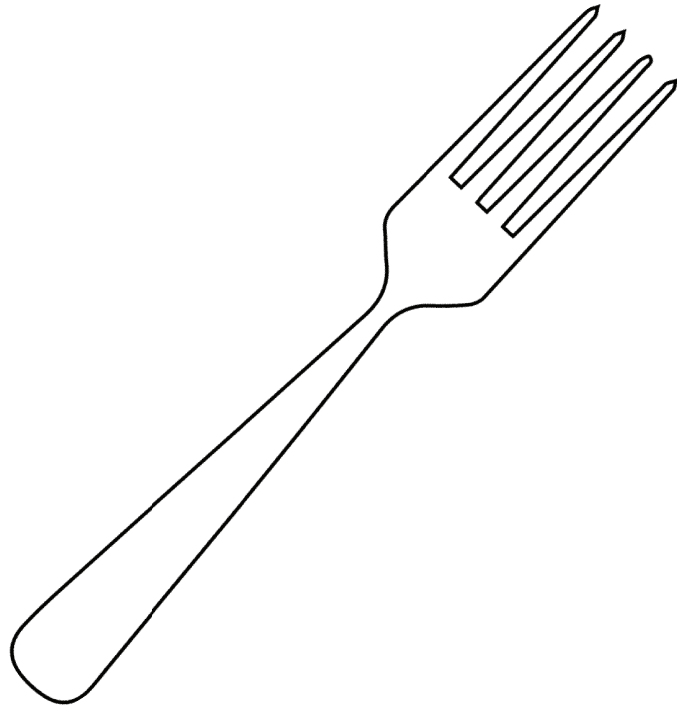

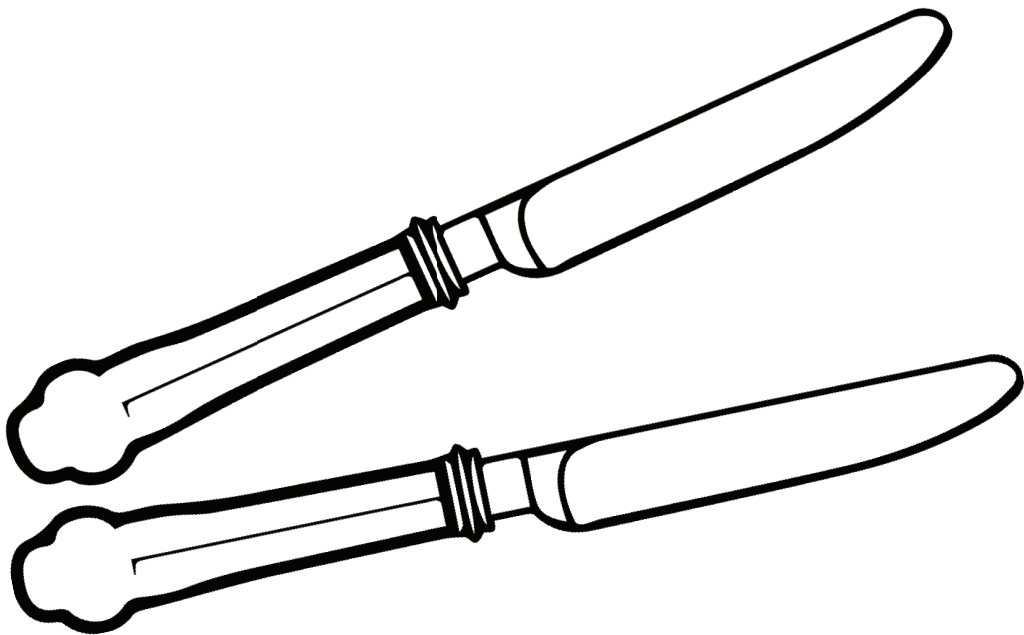
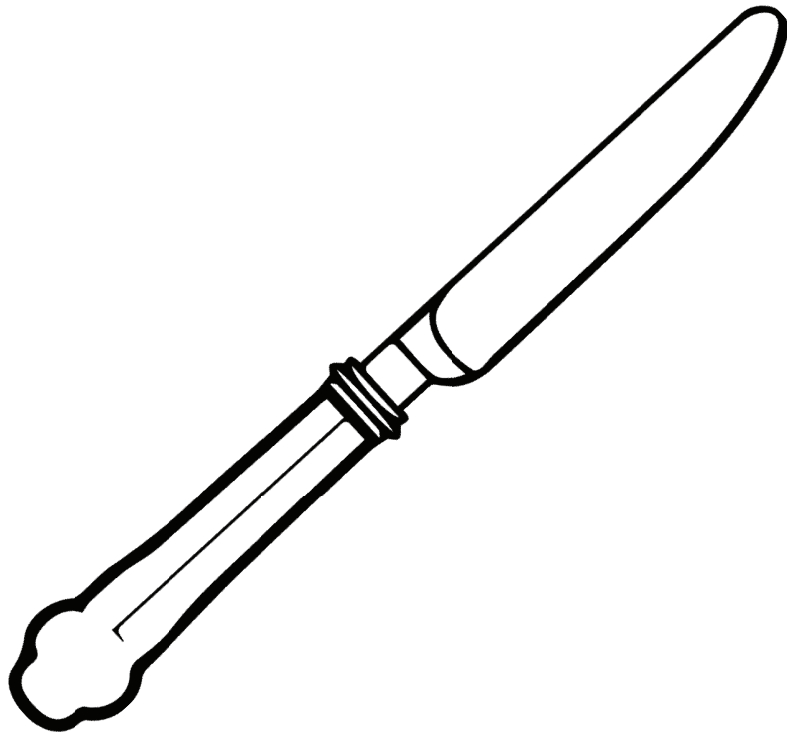

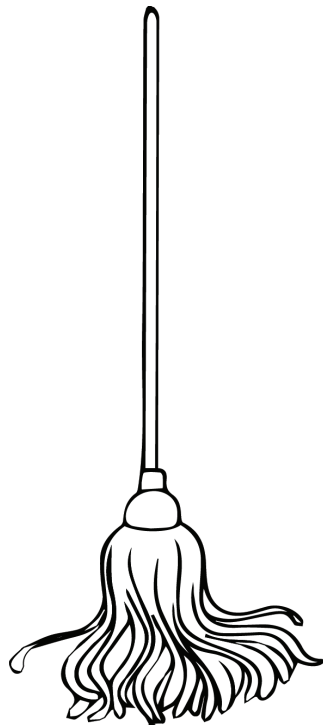
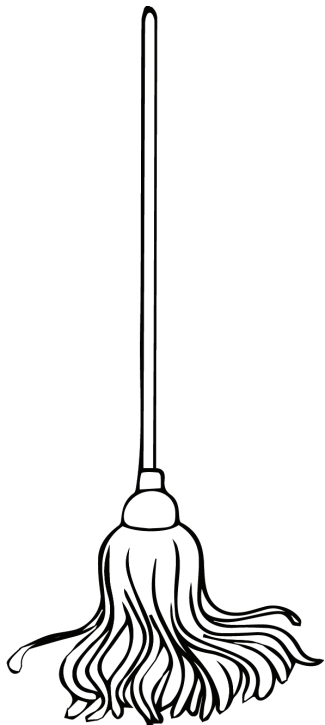
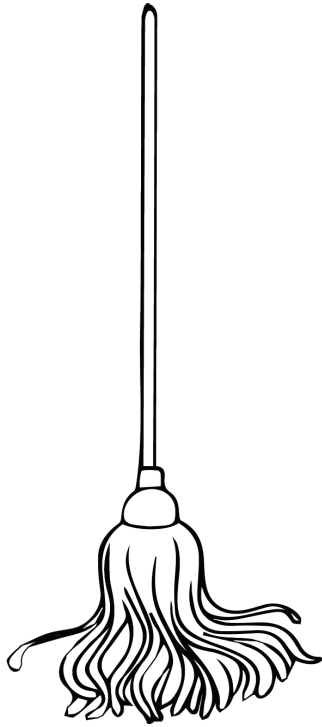

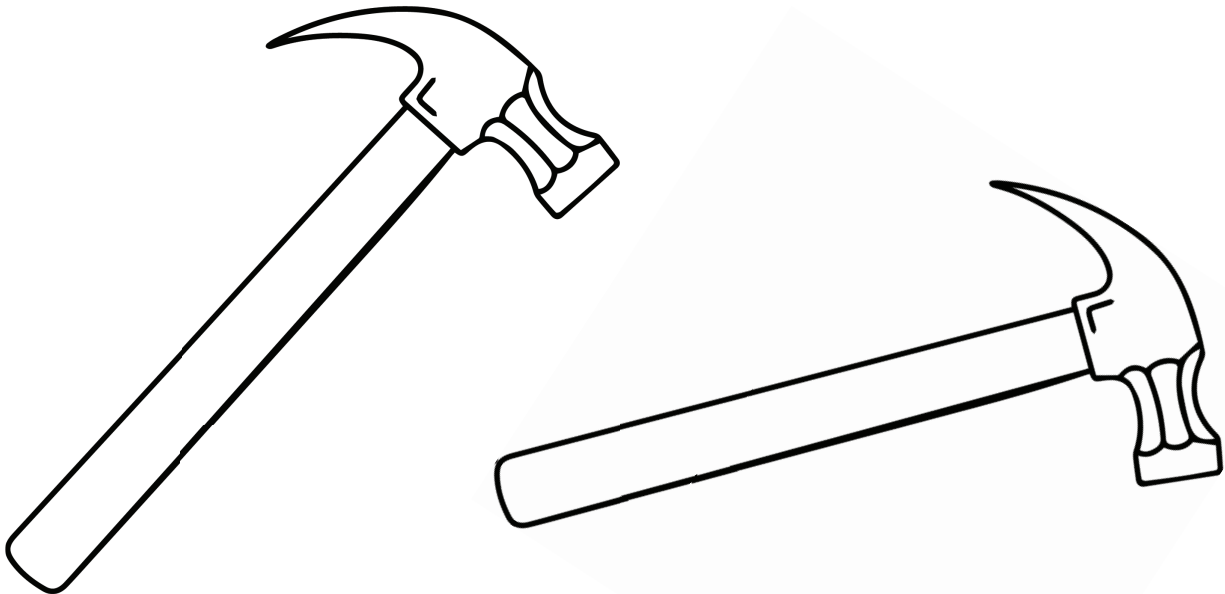
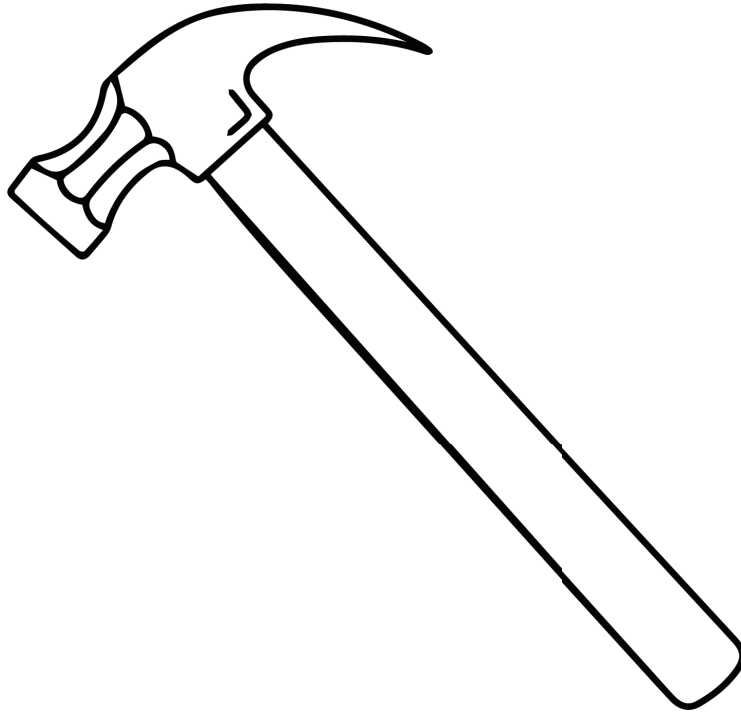

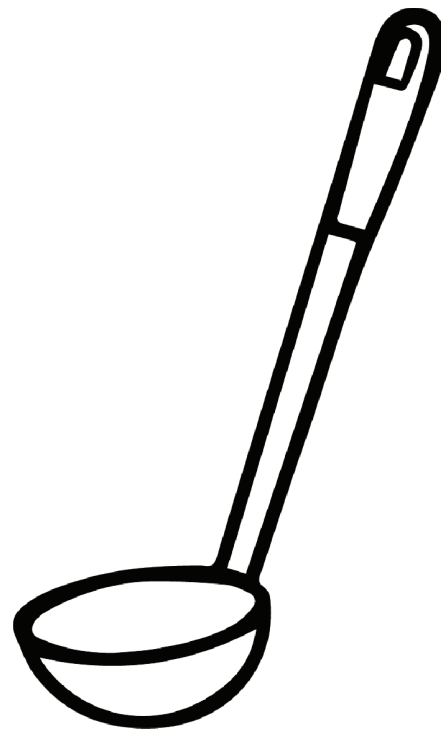
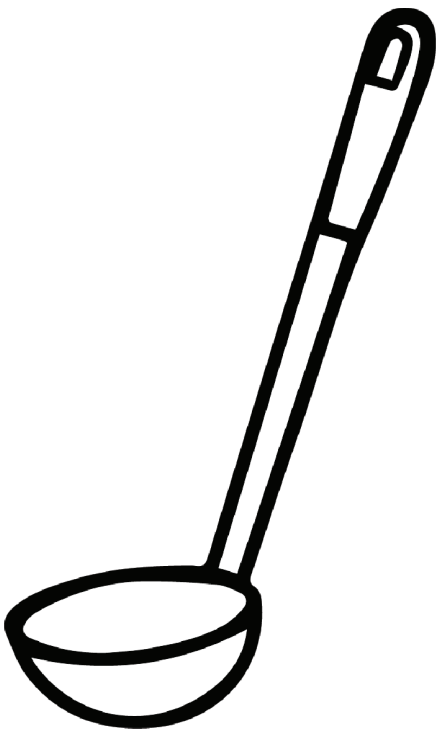
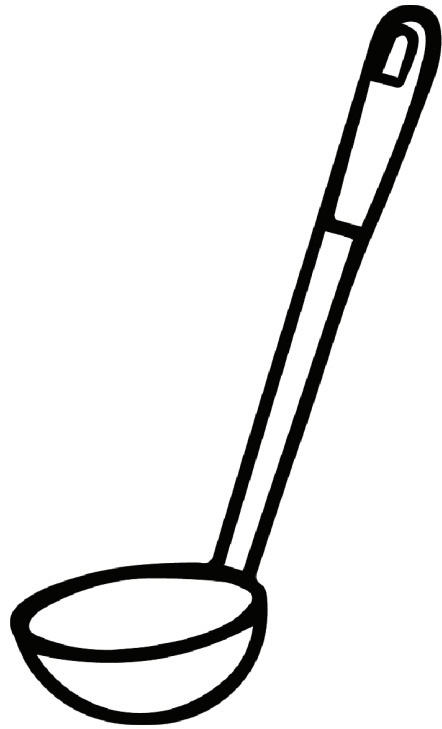

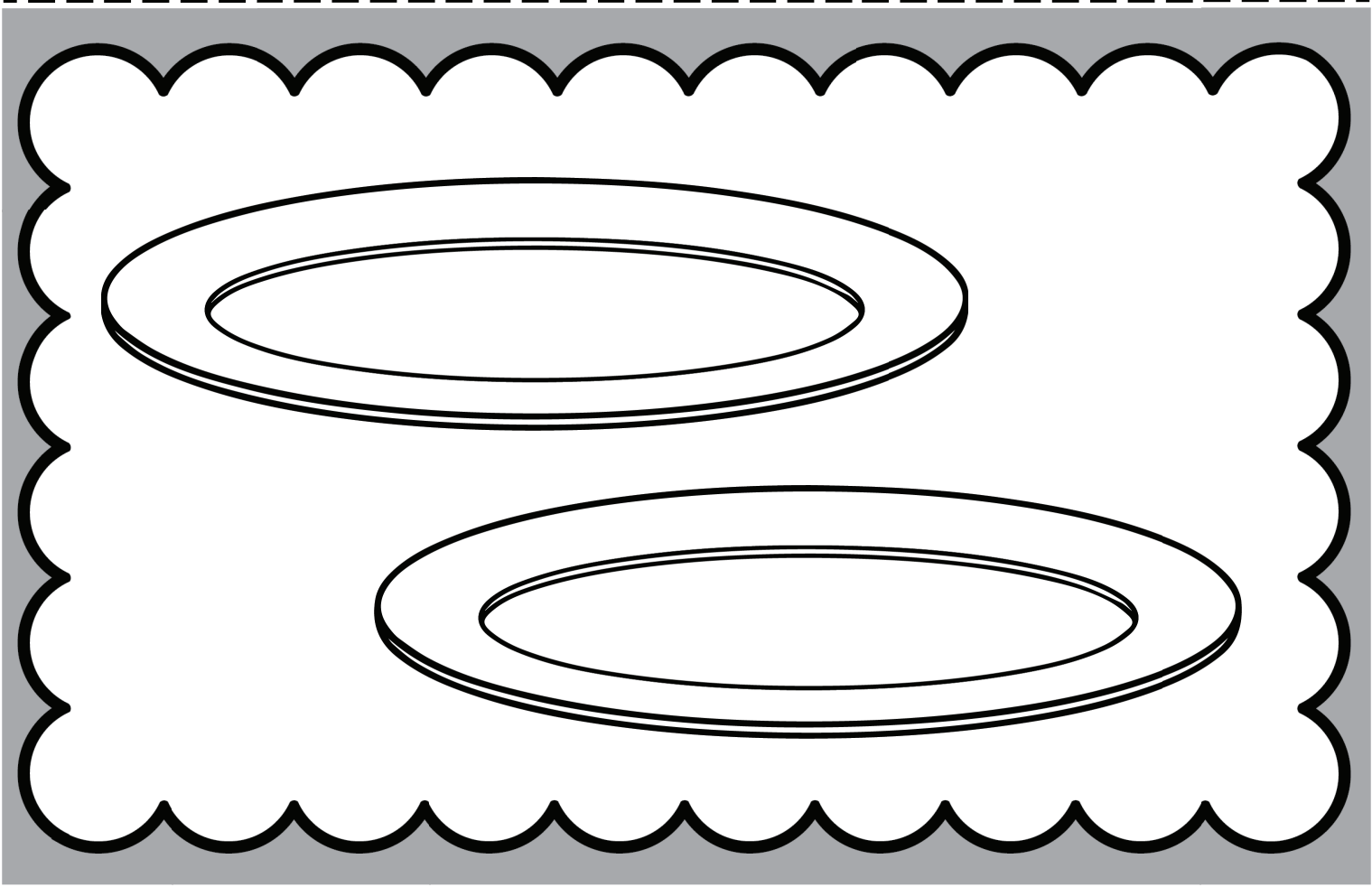
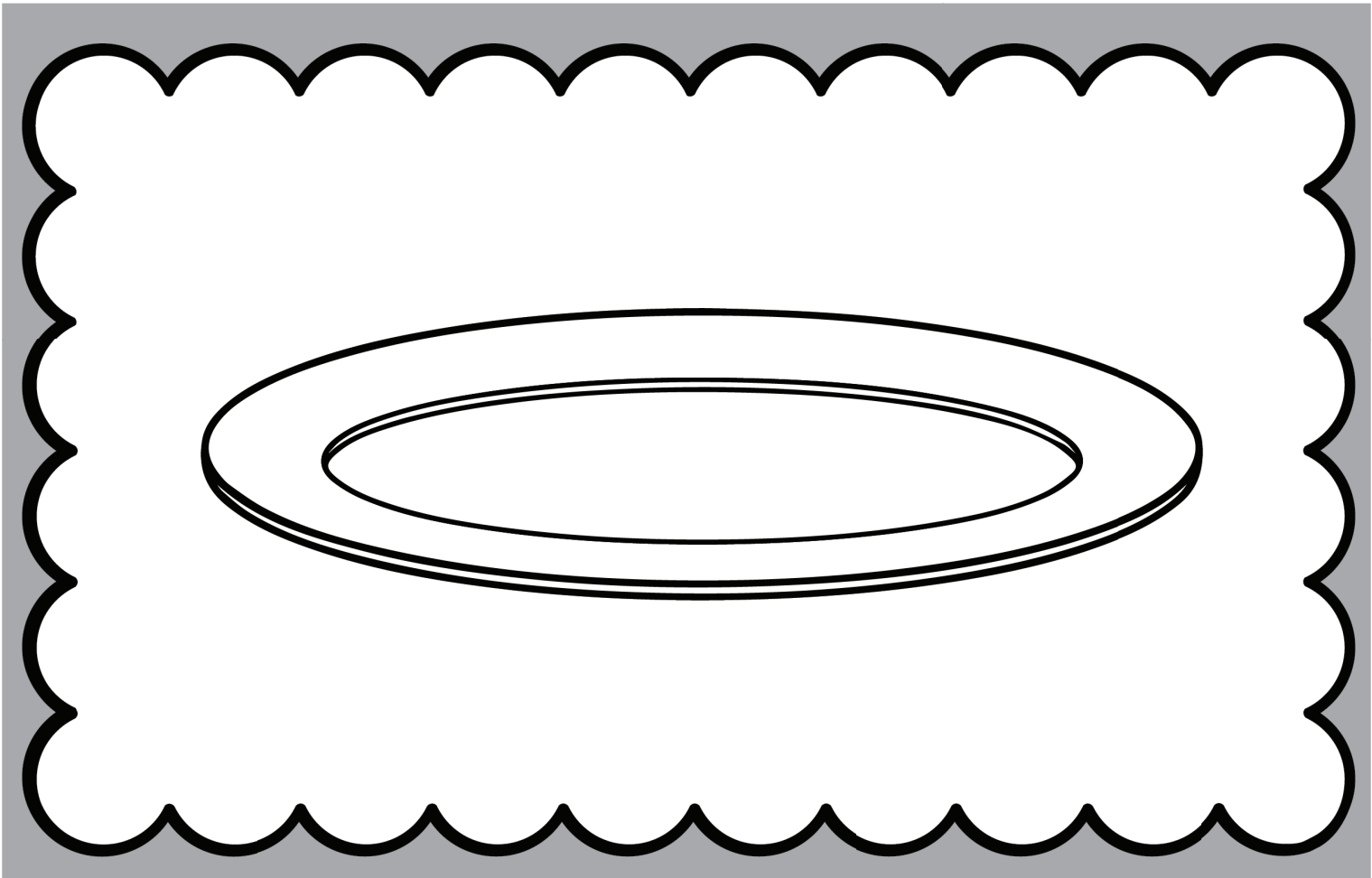

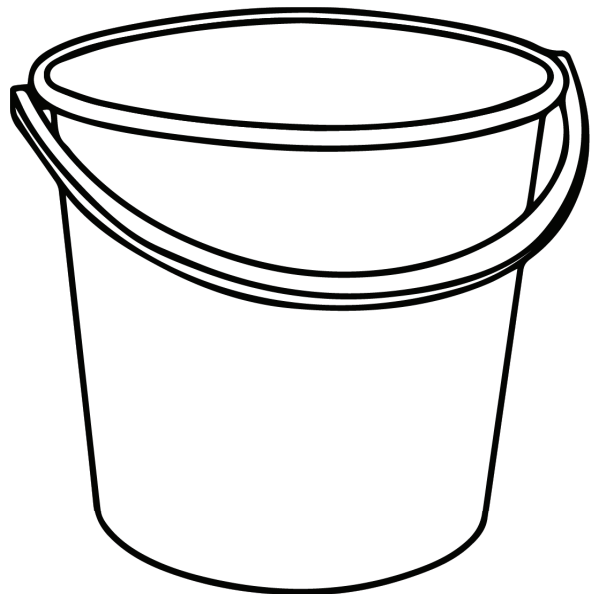
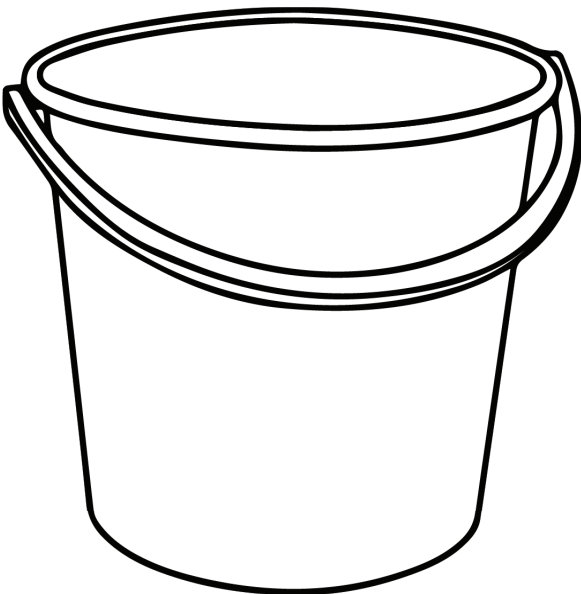
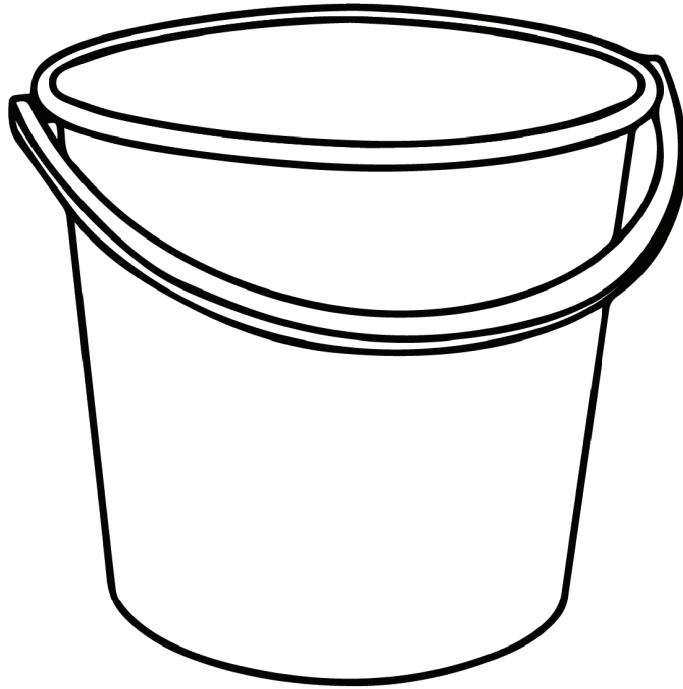

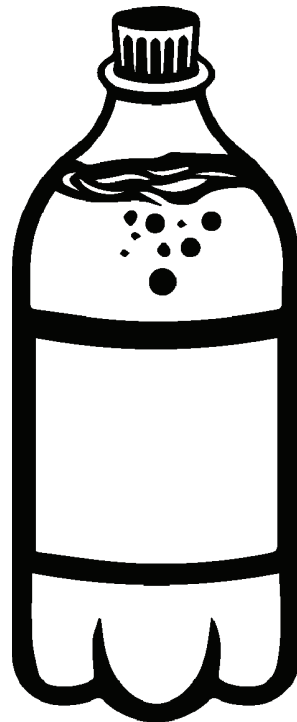
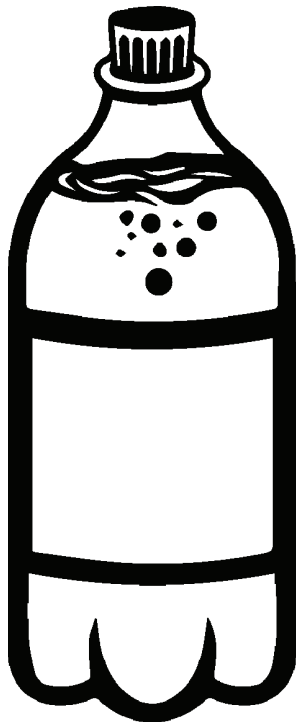
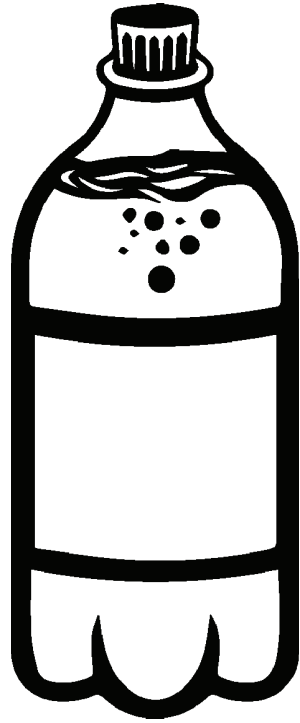



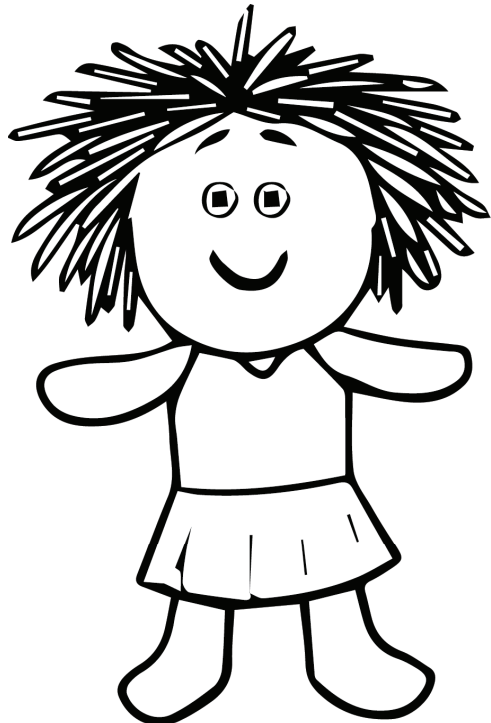
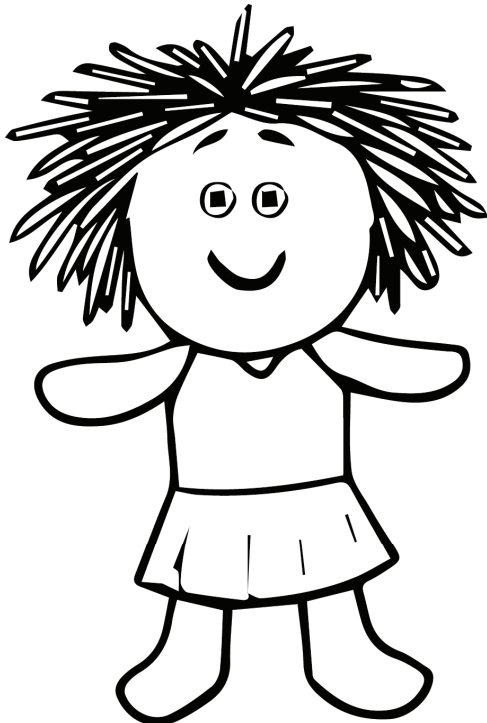
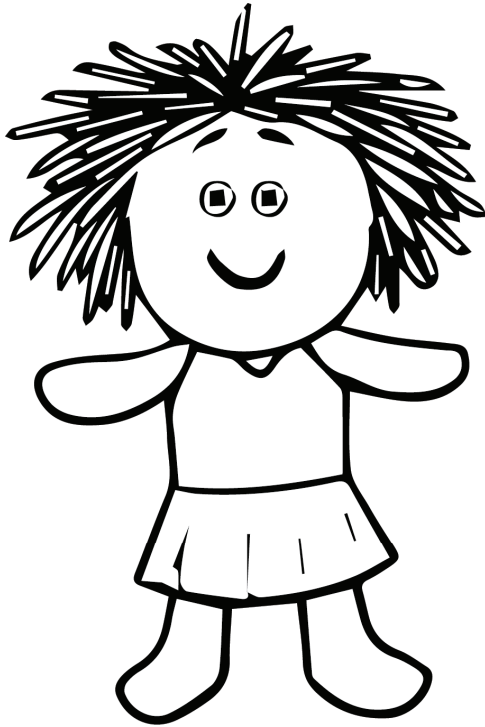



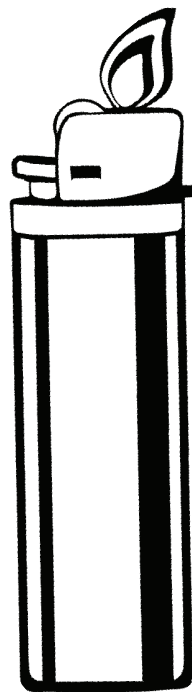
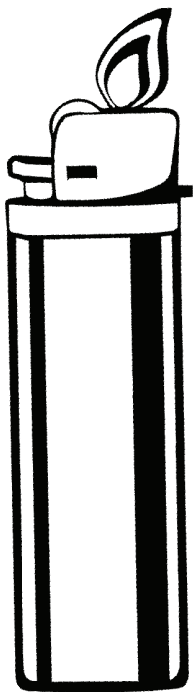
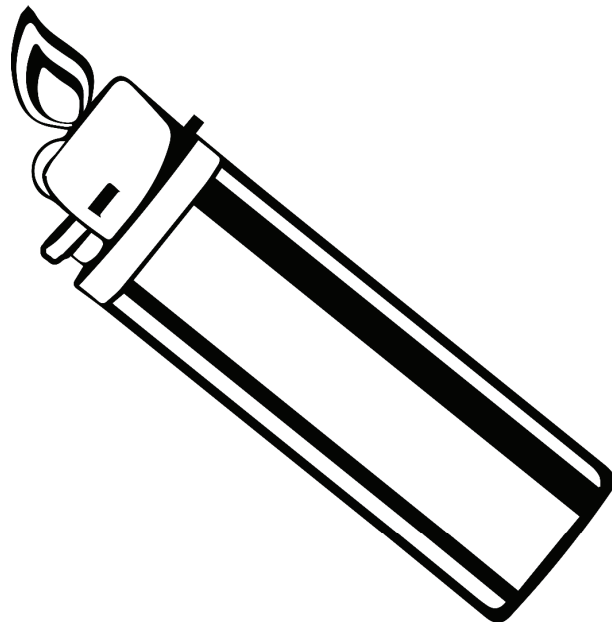

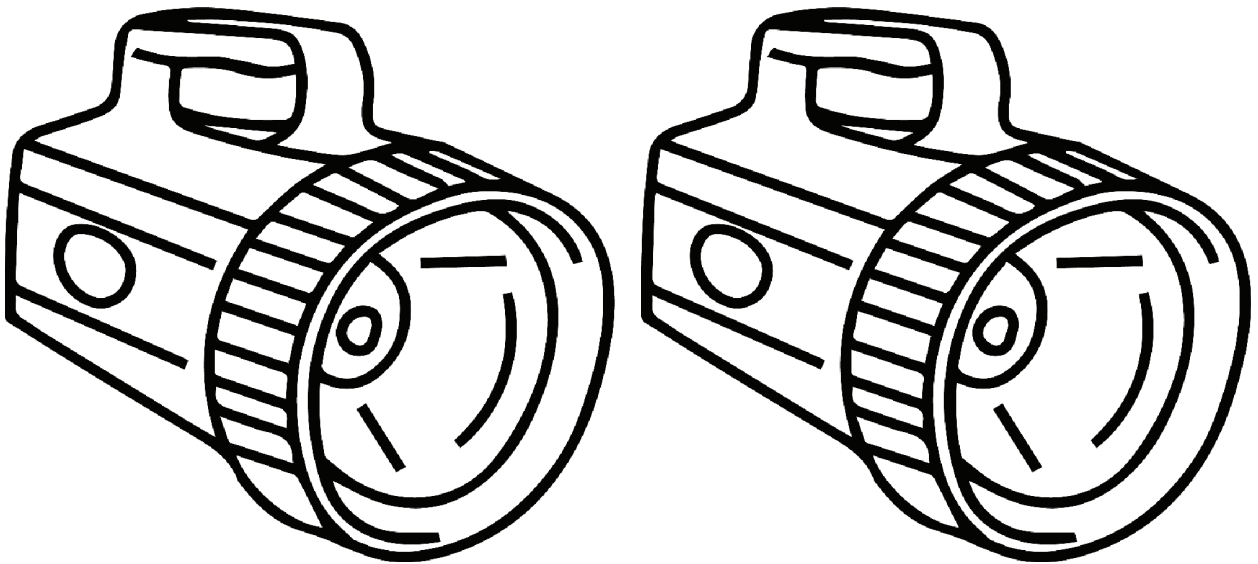
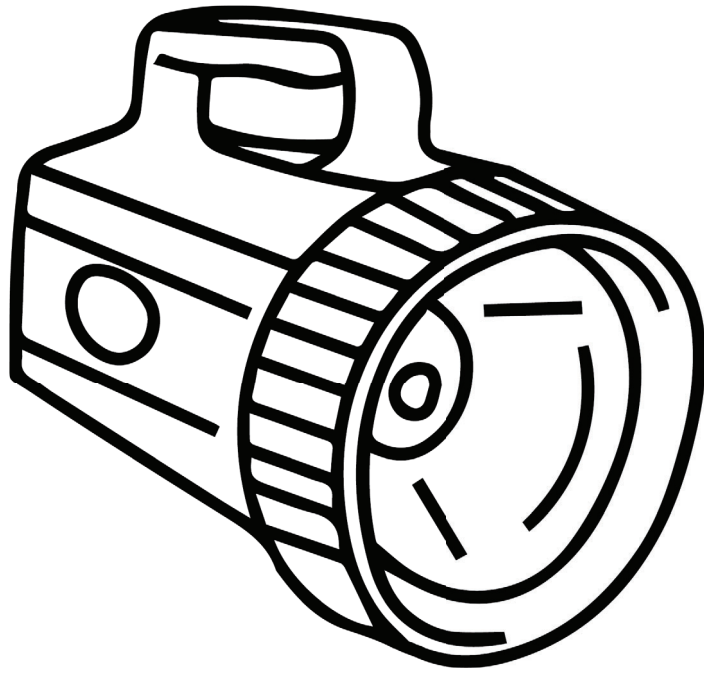

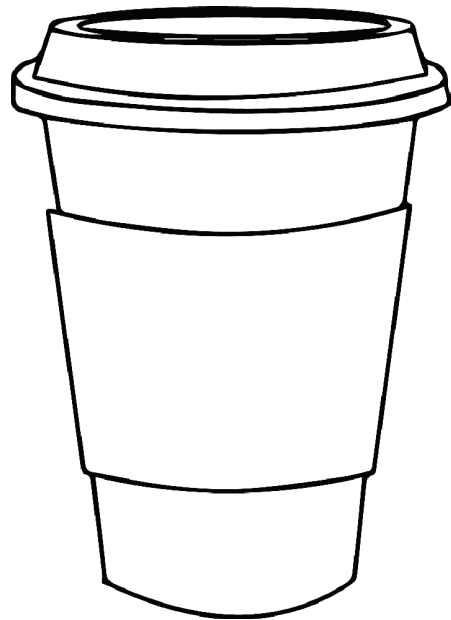
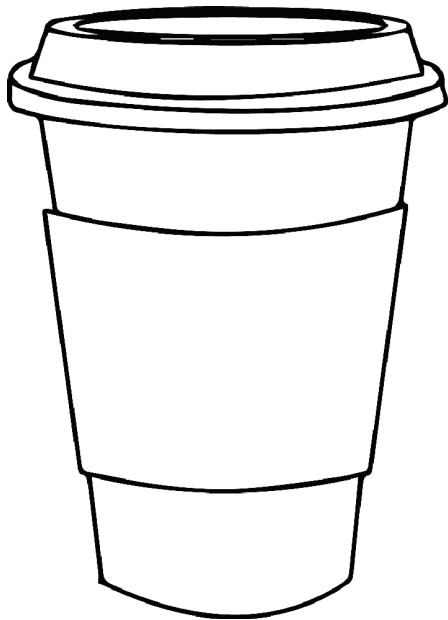
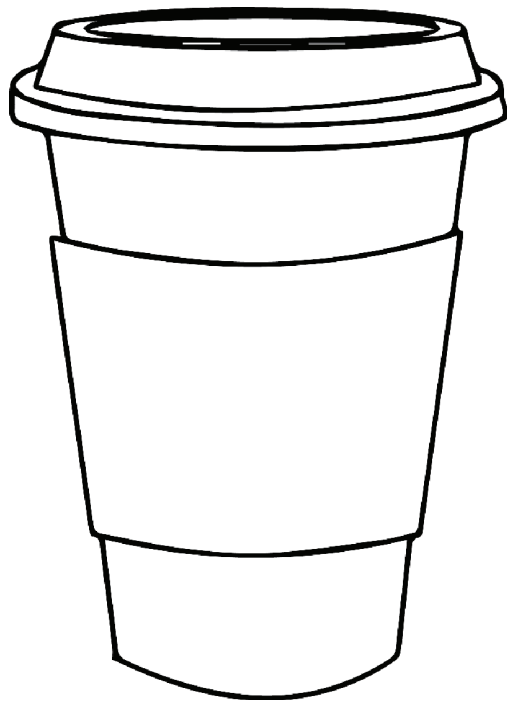

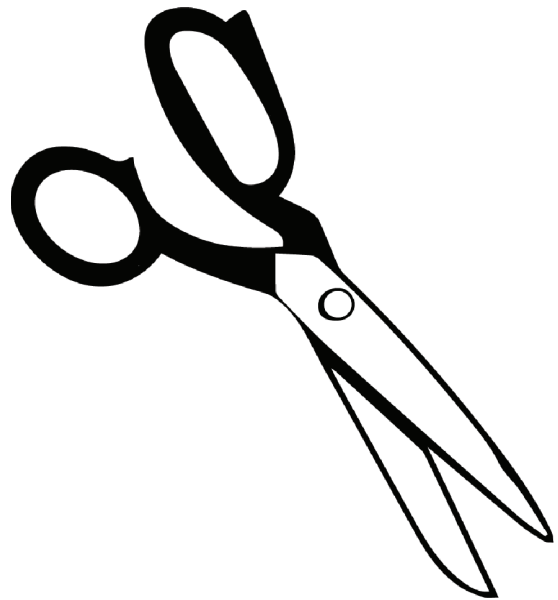

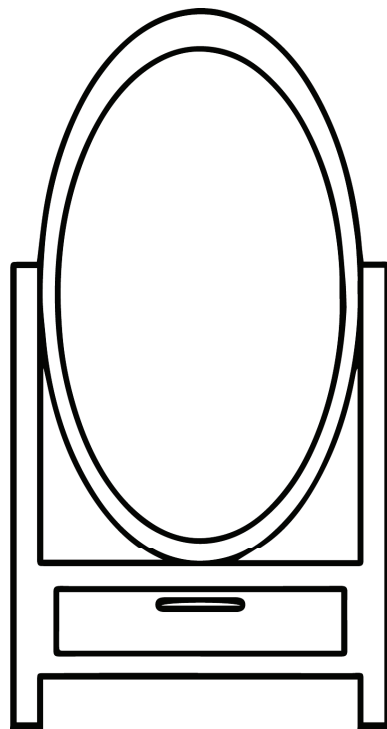
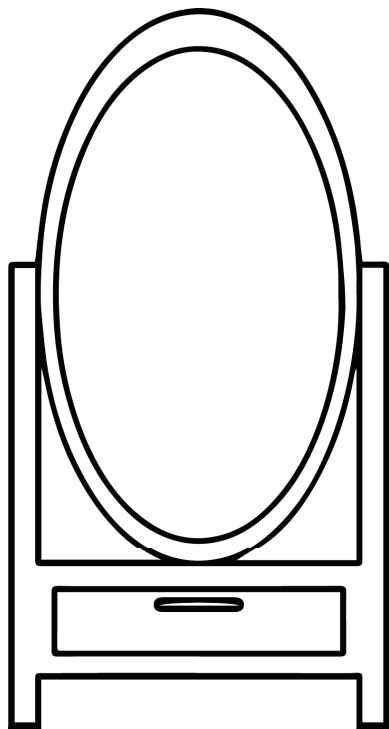
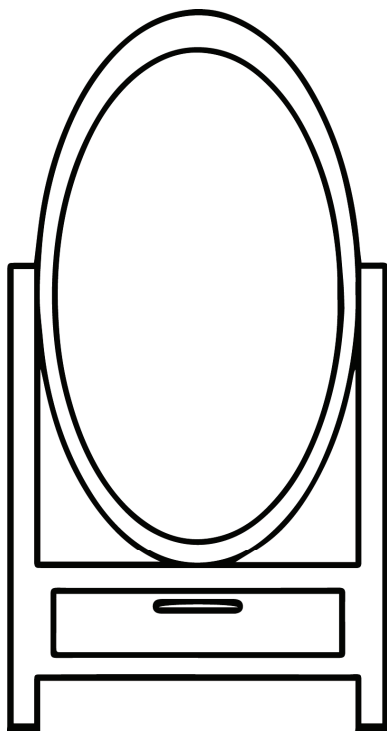

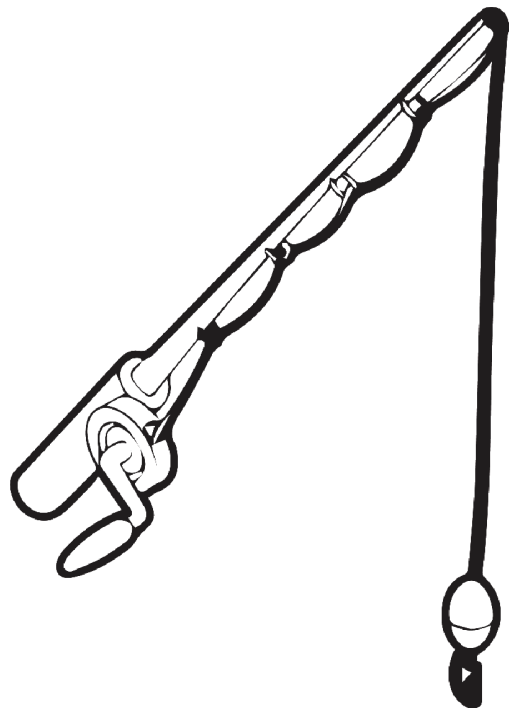
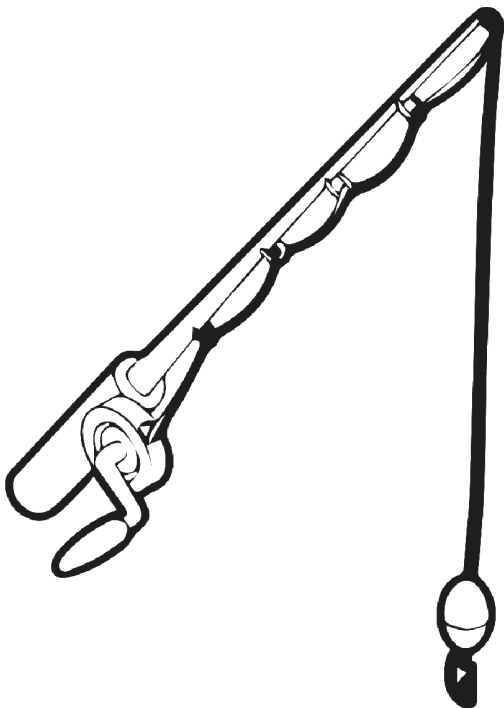
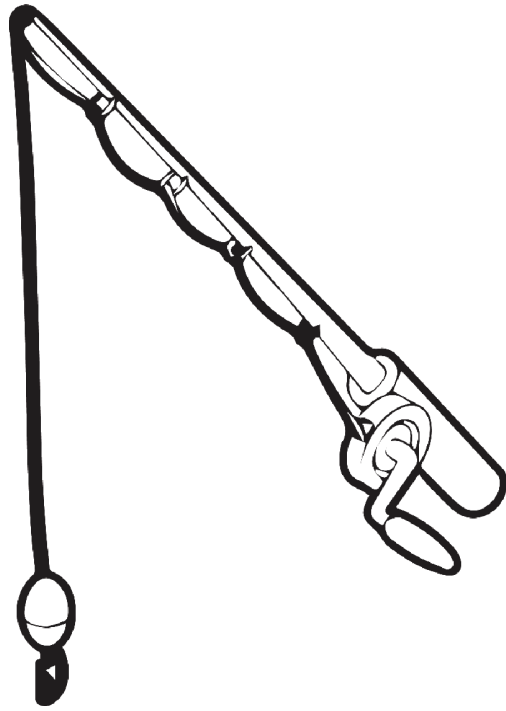



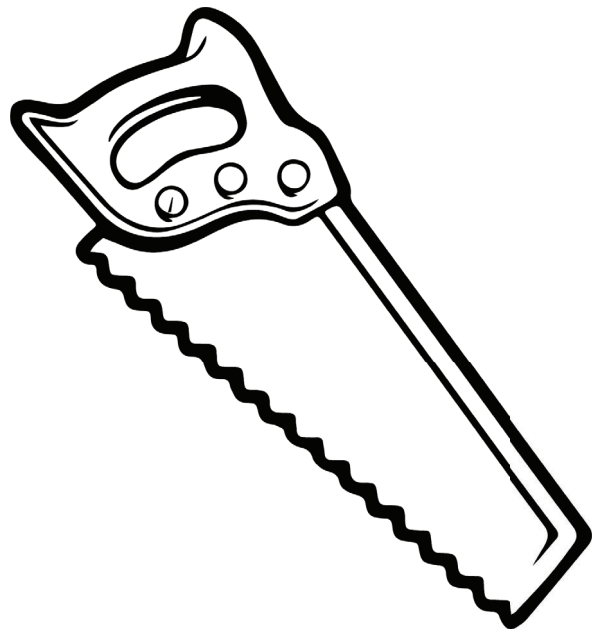
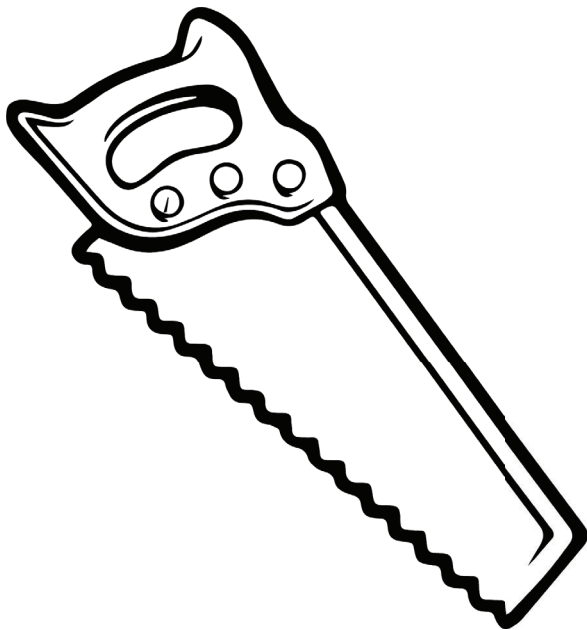

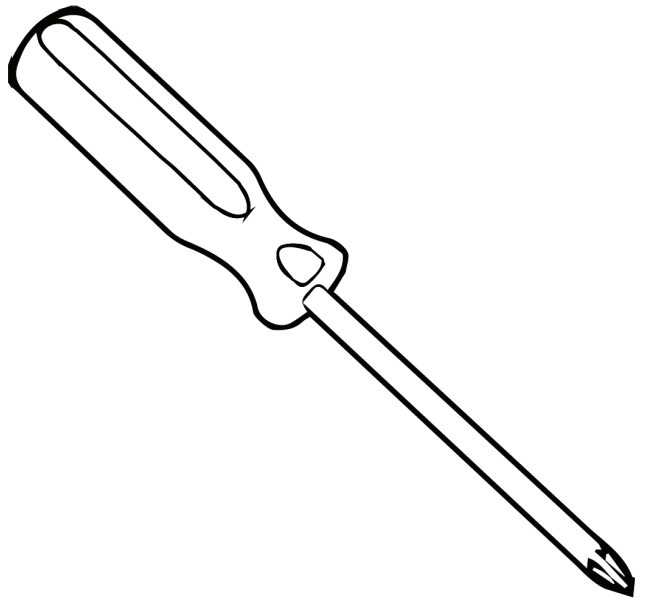
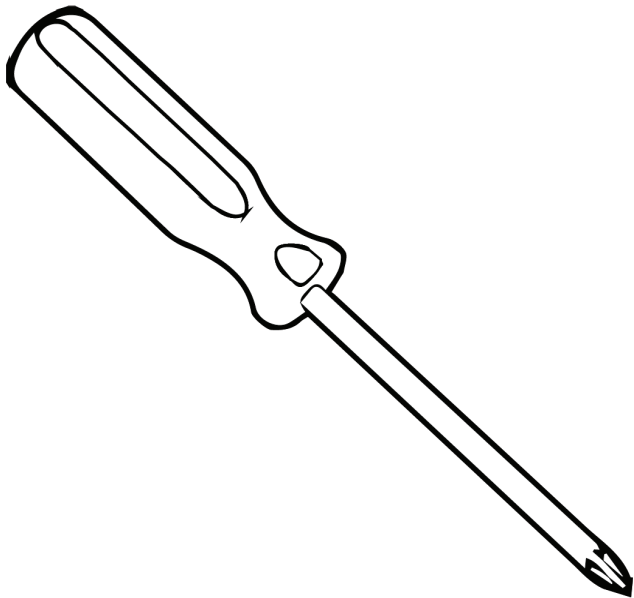
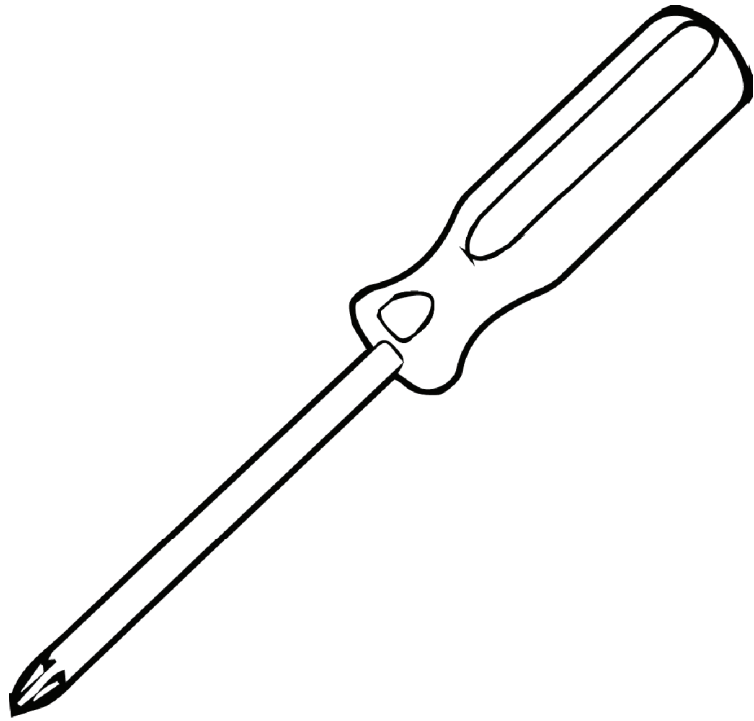

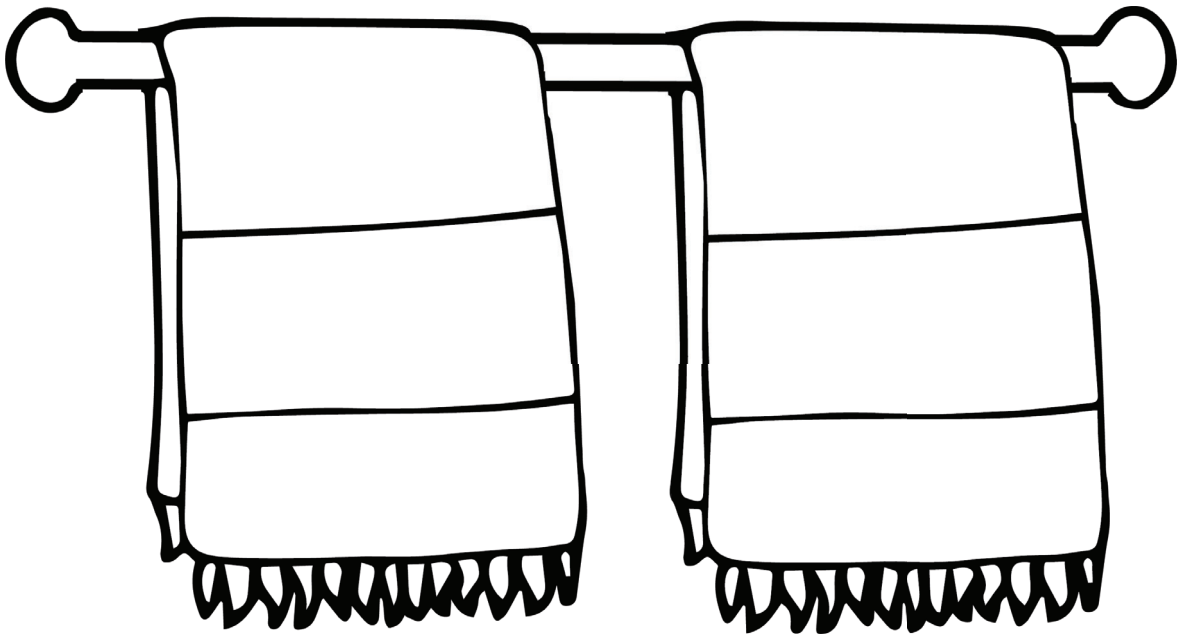
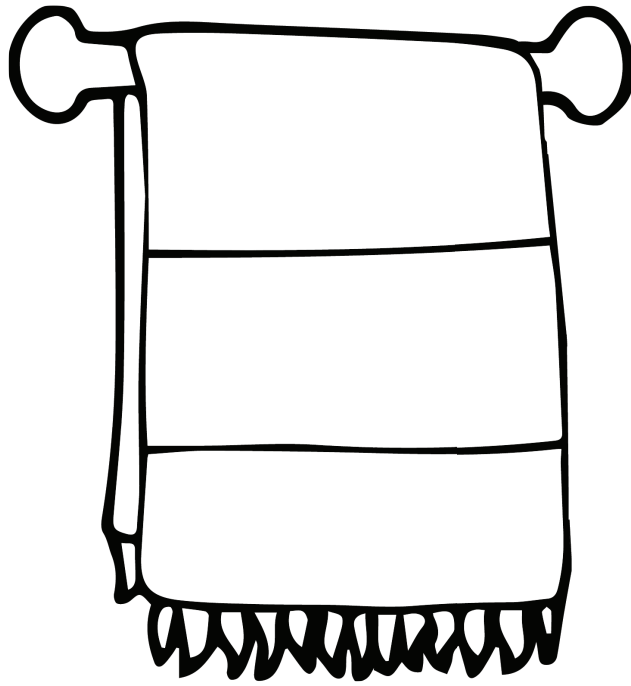

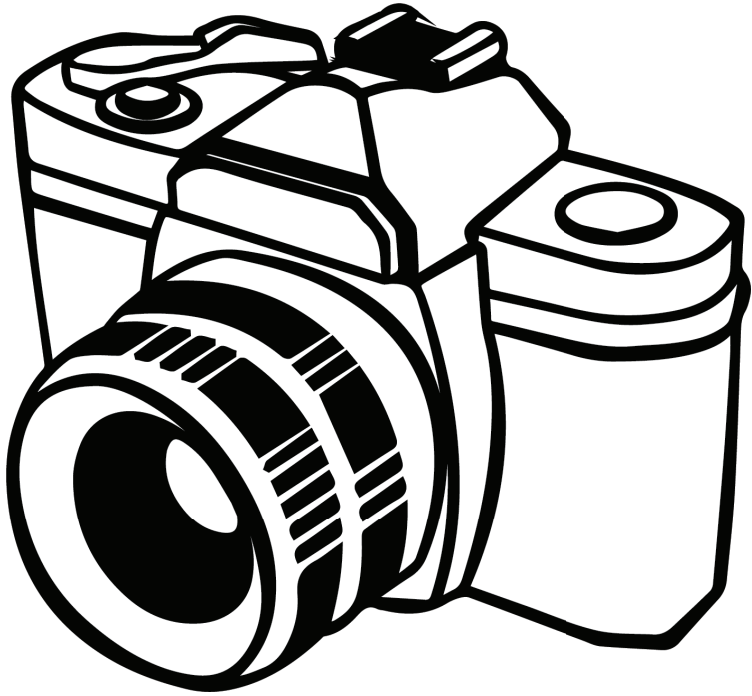



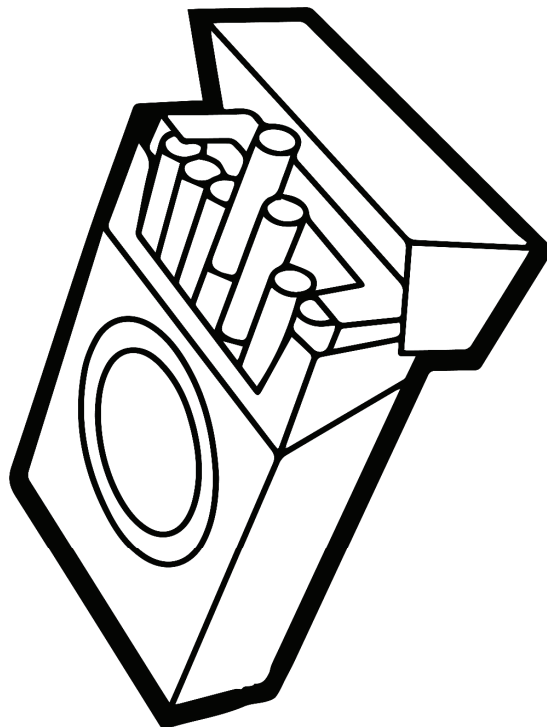
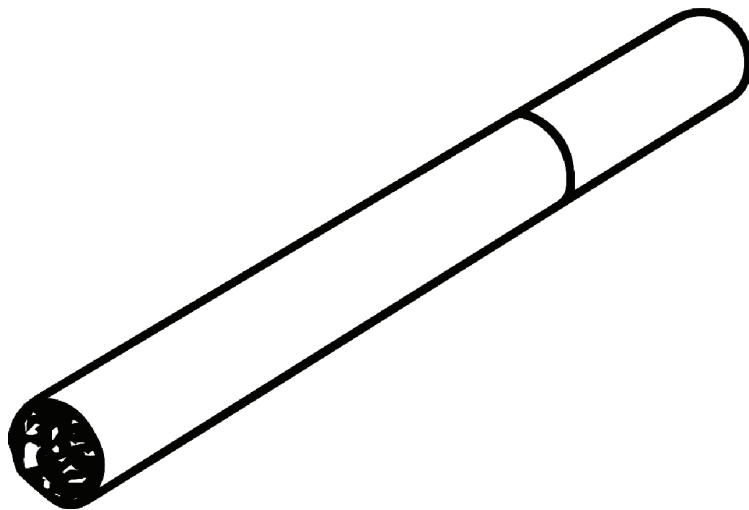

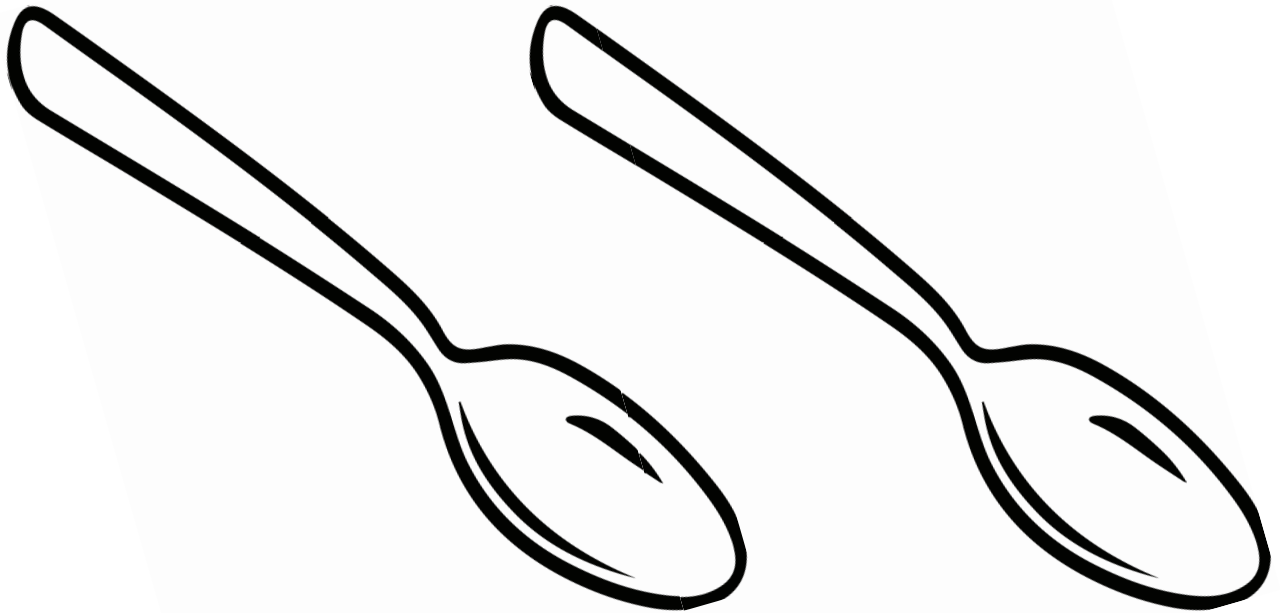
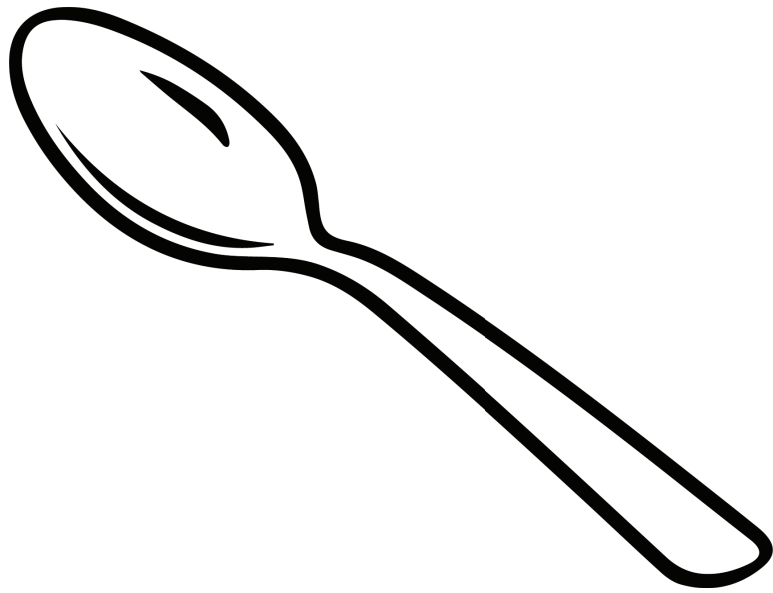



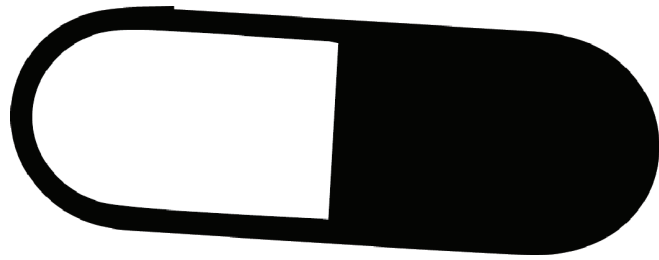



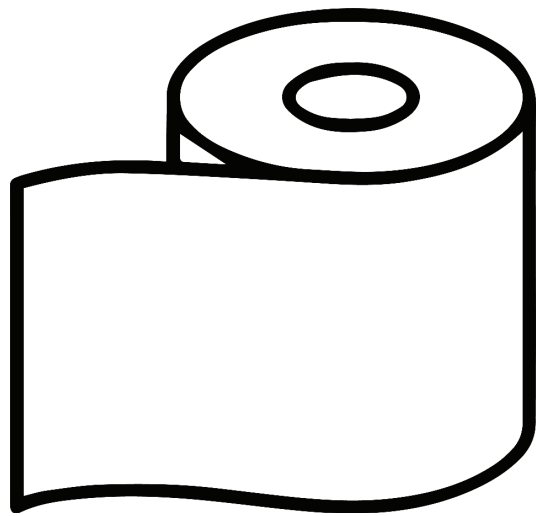
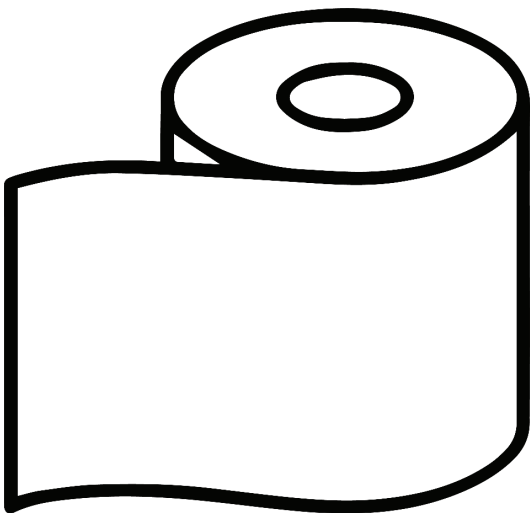
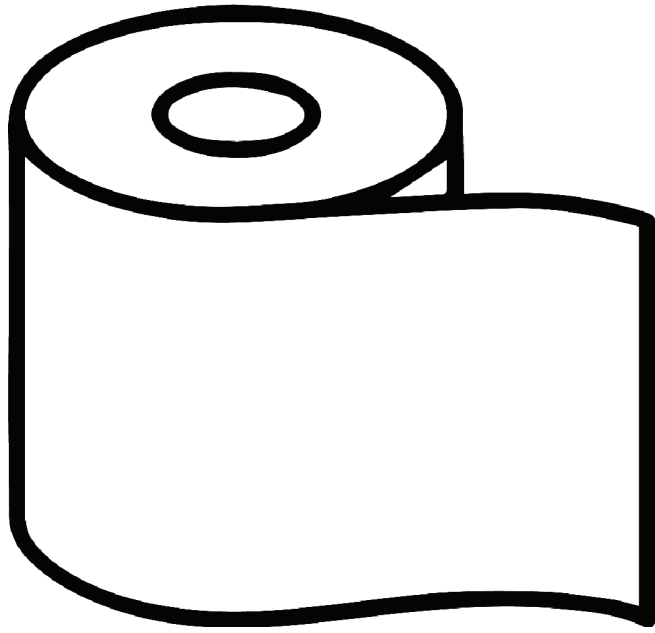

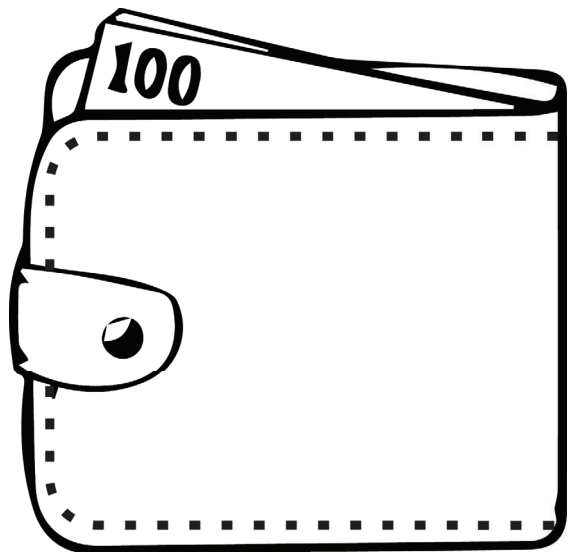
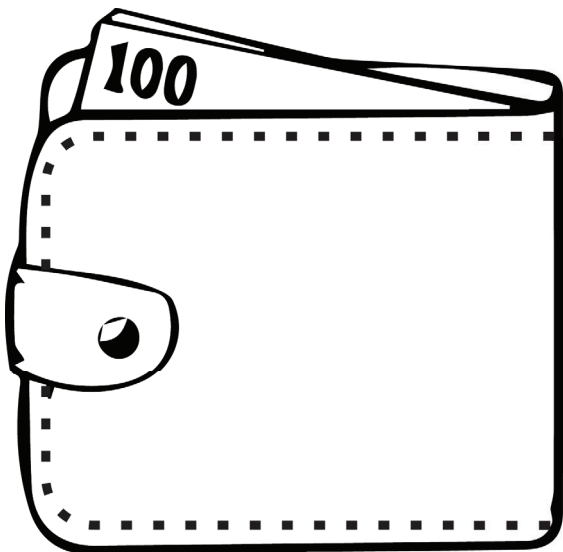
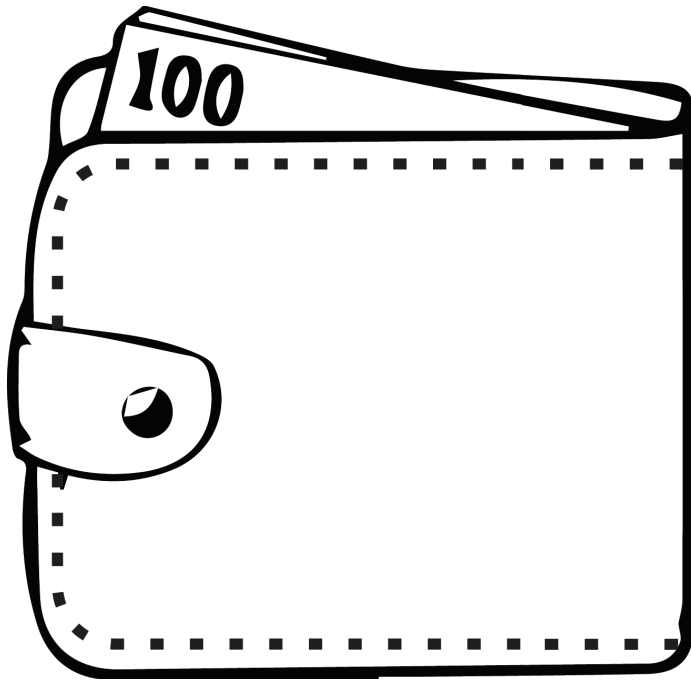

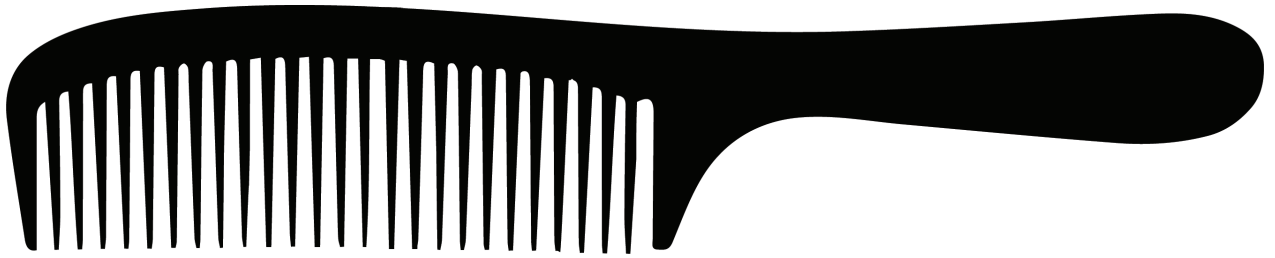
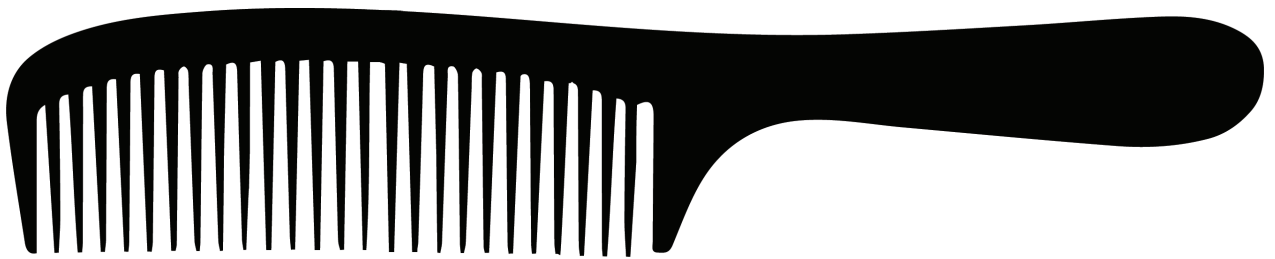
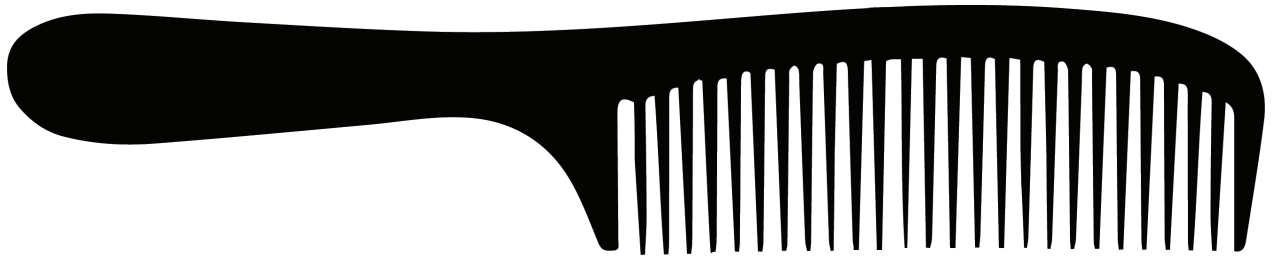

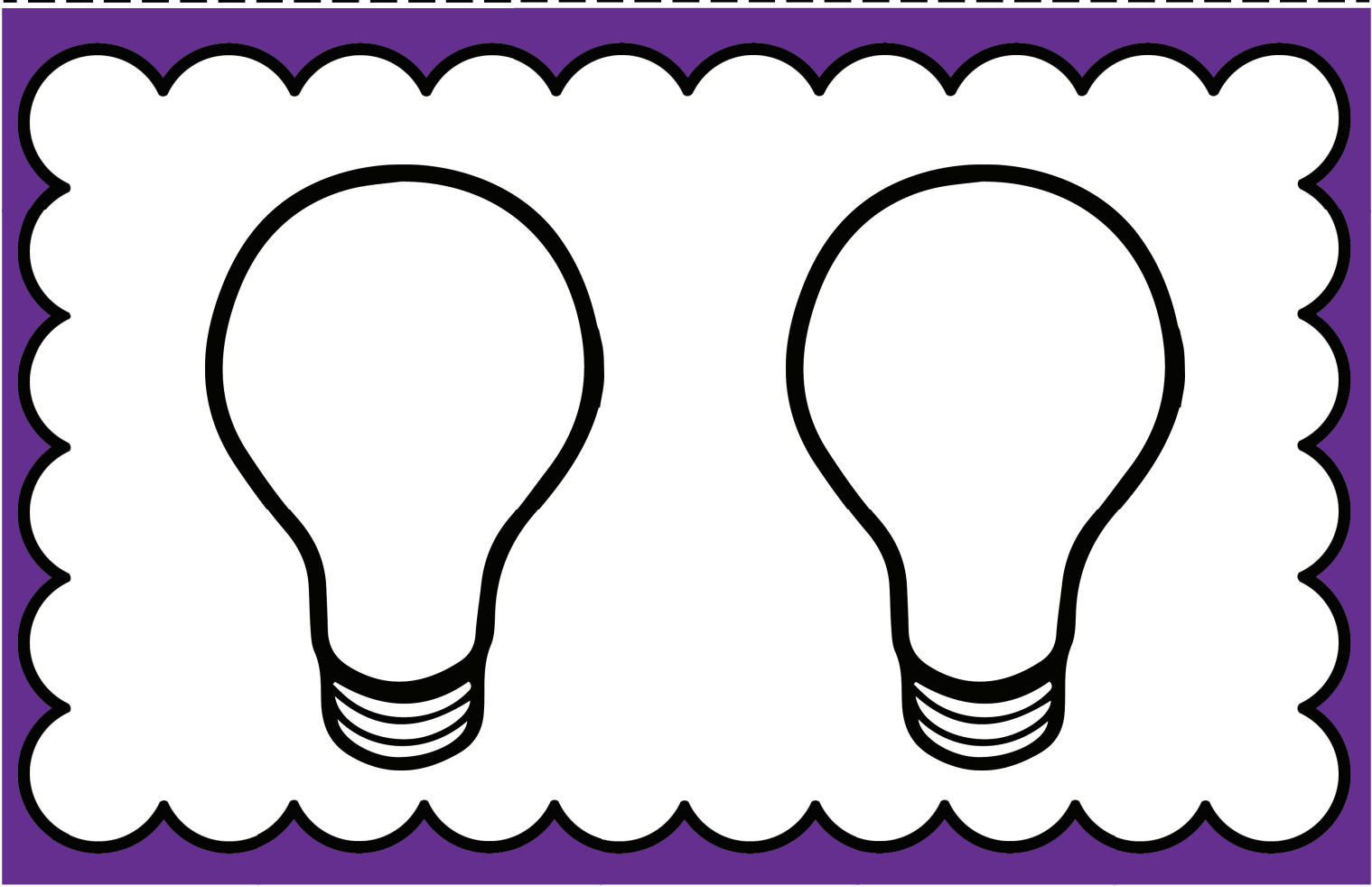
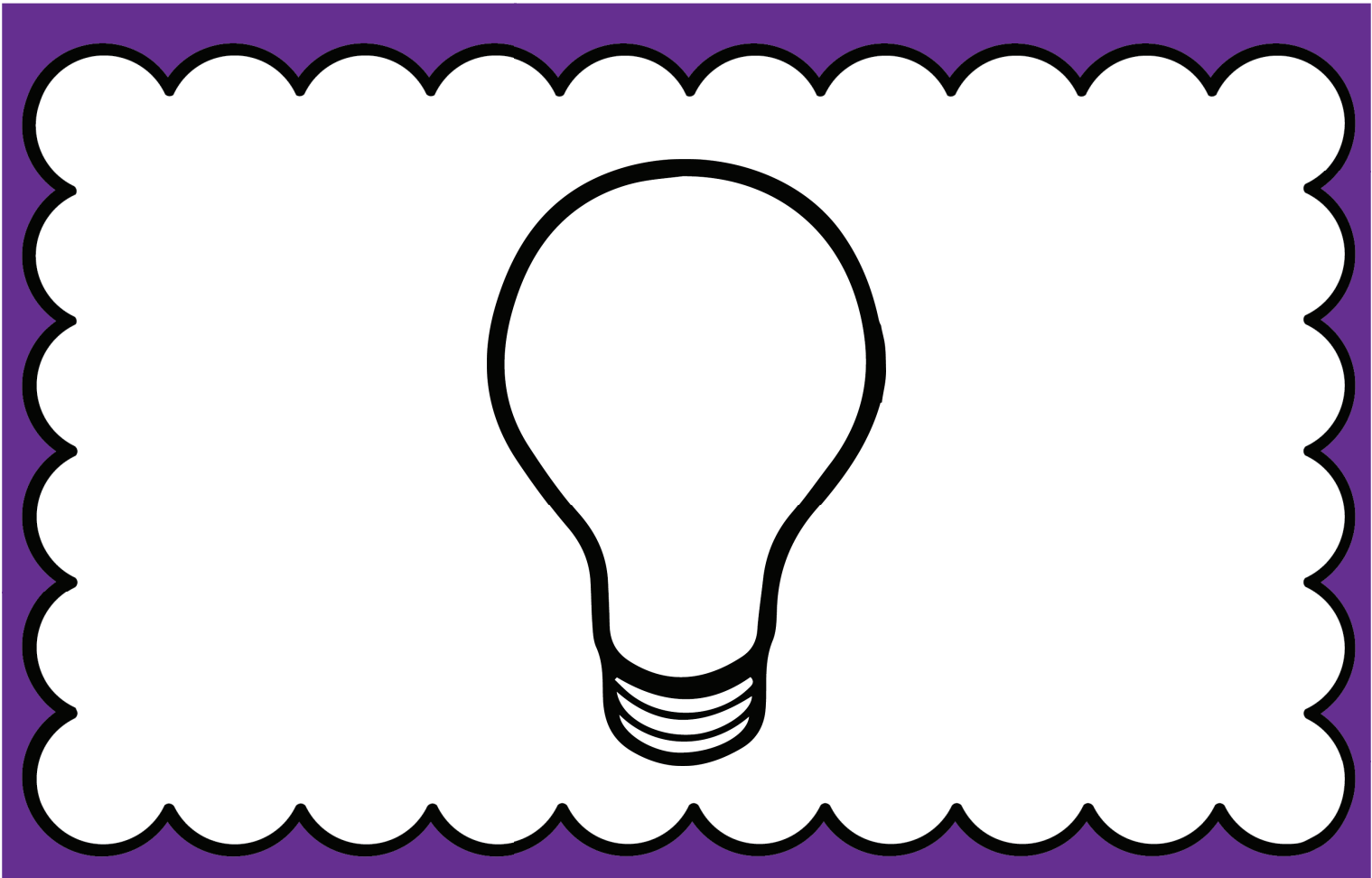

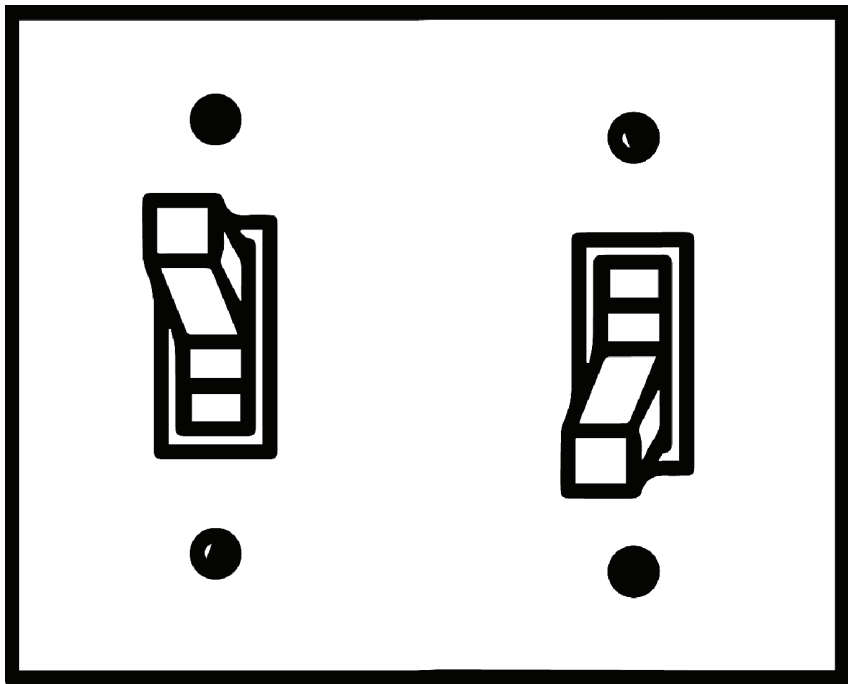
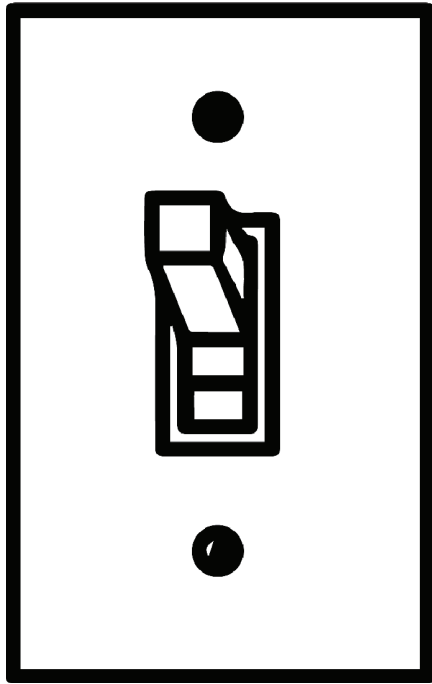

Date _____

PAY TO THE ORDER OF _____ \$

_____ DOLLARS

FOR _____

Date _____

PAY TO THE ORDER OF _____ \$

_____ DOLLARS

FOR _____

Date _____

PAY TO THE ORDER OF _____ \$

_____ DOLLARS

FOR _____

